



GuardUV Germicidal Air Purifier

FOR COMMERCIAL & INSTITUTIONAL APPLICATIONS



Features

- Wall mount and bi-directional ceiling fan models
- 22 and 33 inch UV lamp models
- Quiet 67 cfm fan (30 db)
- 9,000 hour UV lamp life - over 3-years running 8 hours per day
- Energy efficient
- Galvanized steel construction
- Powerful air movement with 67 cfm fan
- UV air disinfection is recognized and endorsed by ASHRAE, The American Society of Heating, Refrigerating and Air-Conditioning Engineers
- 6' cord is included with an option to hardwire or plug-in

Wall or Ceiling Mount Models



STG-33F Wall Mount
STG-33F-CR Ceiling Mount
37 5/8" wide



STG-22F Wall Mount
STG-22F-CR Ceiling Mount
26 1/8" wide



Bi-directional Ceiling Mount

IMPORTANT:

THE 7-FOOT MINIMUM INSTALLATION HEIGHT REQUIREMENT MUST BE OBSERVED TO ASSURE THE SAFETY OF THE OCCUPANTS.



GuardUV Germicidal Air Purifier

FOR COMMERCIAL & INSTITUTIONAL APPLICATIONS

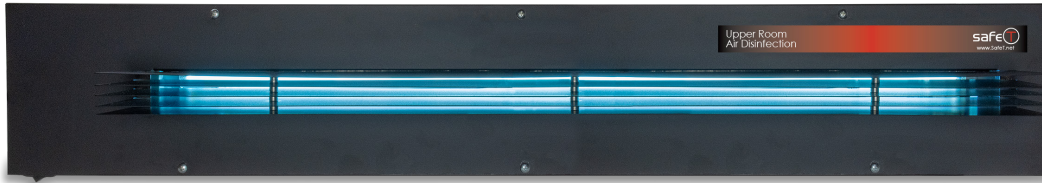

MADE IN
THE USA

Safe and Effective Ultraviolet Air Disinfection for Occupied Spaces

Safe-T GuardUV Germicidal Ultraviolet Air Purifier destroys airborne pathogens by generating a controlled region of germicidal UV light in the upper regions of a room. Pathogenes are drawn through the UV lamp chamber, exposing them to high-intensity germicidal UV light and then released into the upper air of the room where they are exposed to additional focused UV light. The UV light disinfection field is restricted to the upper area of the room (must be installed at least seven feet from the floor).

UV Effectiveness Against Various Microbes

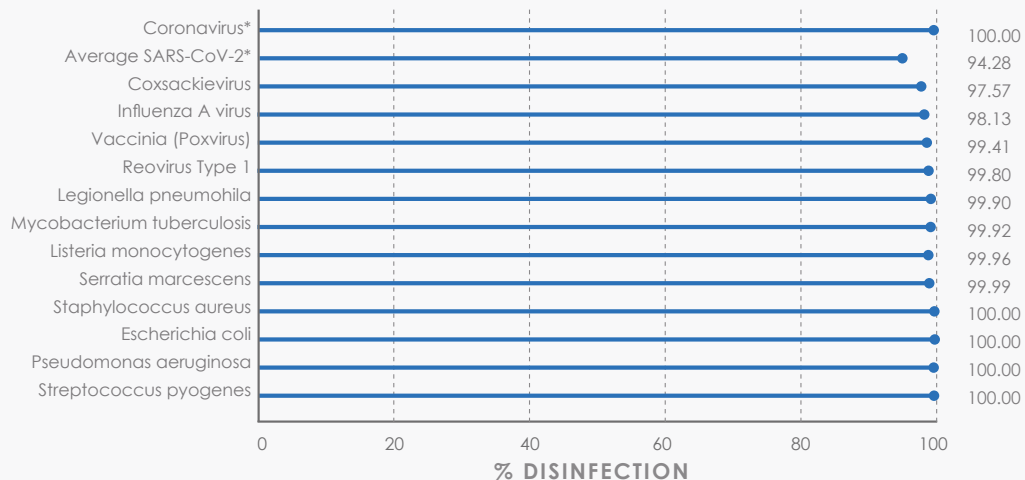

Percentage disinfection calculations are based on the intensity at end of (9,000 hours) lamp life
*There are many strains of coronavirus that have been identified, this chart lists just two

Air Flow

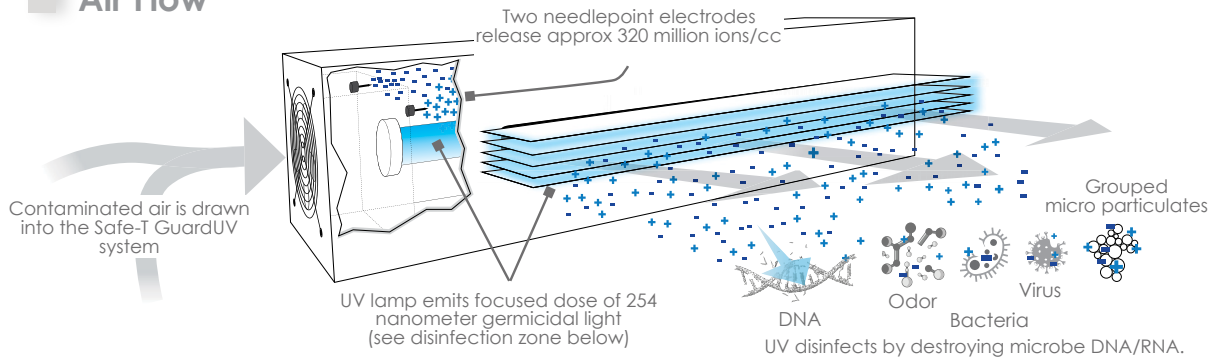

Unit Features

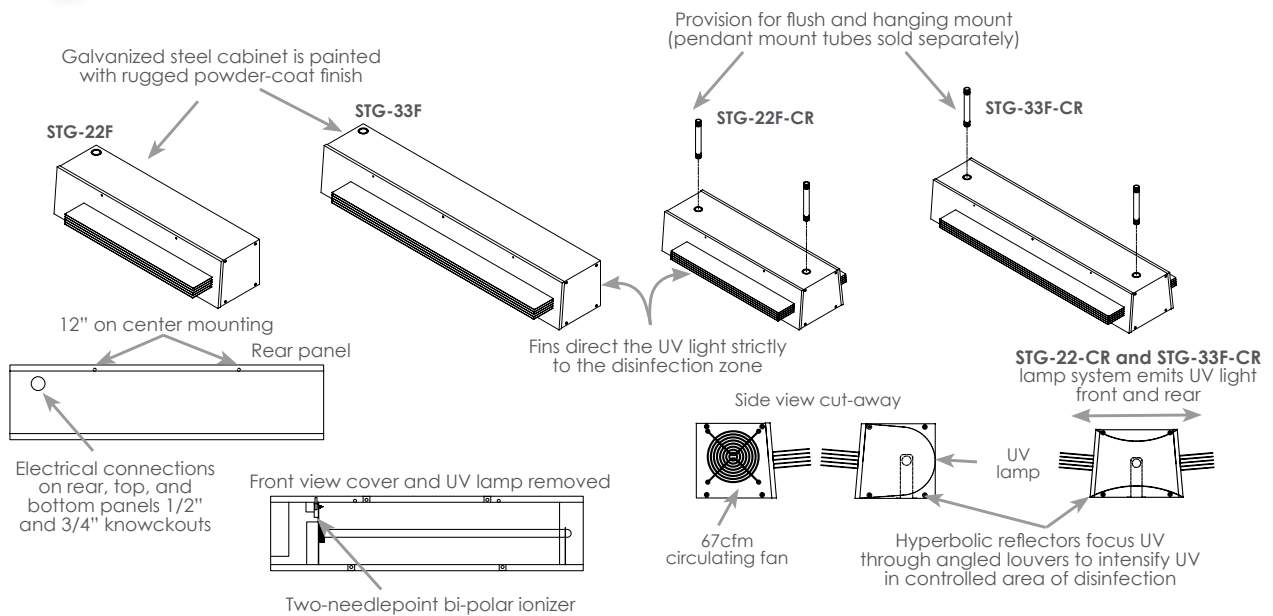

Safe-T GuardUV Upper Air Irradiance

STG-22F 15 x 20 ft room

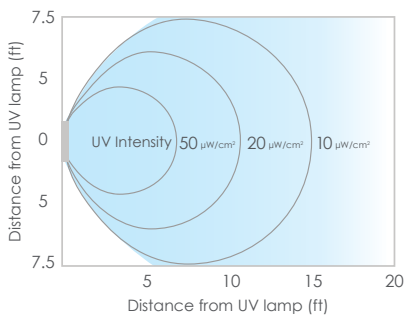

Safe-T GuardUV Air Circulation Through Disinfection Zone

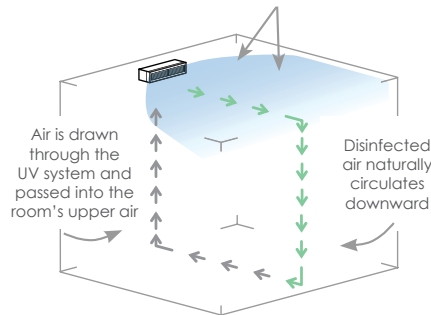

Safe-T GuardUV Ceiling Mount for Extended Coverage

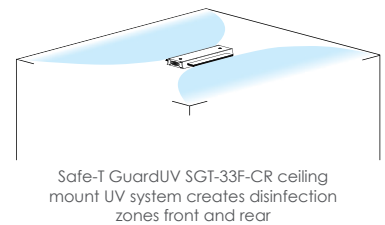



safe-T **GuardUV**
Germicidal Air Purifier
 FOR COMMERCIAL & INSTITUTIONAL APPLICATIONS

Safe-T GuardUV
 Typical placement
 for various models

Specifications

Model	Coverage sq. ft.	Total UV-C output	UV lamp wavelength	UV lamp life	Power consumption	Width	Height	Depth
STG-22F Wall Mount	225 (15'x15')	10w	254nm	9,000 hrs	36.5VA	26.1"	6.1"	9.2"
						66.29cm	15.49cm	23.37cm
STG-33F Wall Mount	350 (16'x22')	16w	254nm	9,000 hrs	44.5VA	37.7"	6.1"	9.2"
						95.76cm	15.49cm	23.37cm
STG-22F-CR Ceiling Mount	450 (15'x30')	10w	254nm	9,000 hrs	36.5VA	26.1"	6.1"	13.5"
						66.29cm	15.49cm	34.29cm
STG-33F-CR Ceiling Mount	700 (16'x44')	16w	254nm	9,000 hrs	44.5VA	37.7"	6.1"	13.5"
						95.76cm	15.49cm	34.29cm

Power: All models auto-sensing 120-277 VAC, 50/60 hz.
Important: When installed, bottom of fixture must be at least 7 feet above the floor.

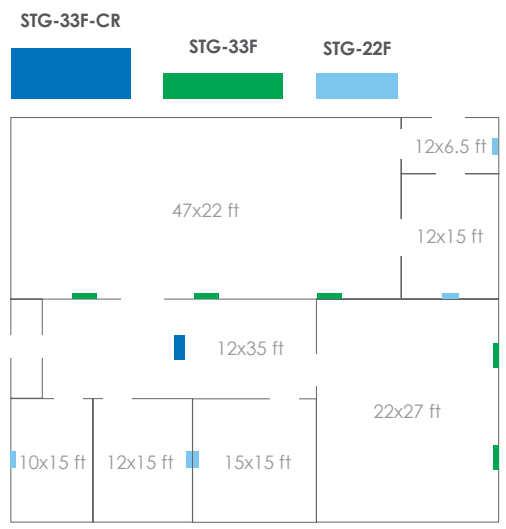

Contact Safe-T for information on the number of units required based on room size, and for placement suggestions

Member

EPA establishment number: 074725-VT-001

safe-T Workplace Products

For more information
 contact Safe-T Sales Team
 888.705.0777