



Contract Holder
Contract # GS-28F-0014W / GS-28F-0015W

PRICE LIST

GS-28F-0014W | GS-28F-0015W

Effective March 10, 2023



UEI # JN35LUM5XR97

PRICING & FREIGHT NOTIFICATIONS

Pricing Disclaimer

Although the information in this Price List is presented in good faith and believed to be correct at the time of publication, Special-T has no liability for any errors or omissions. Also, please note that all prices are subject to change.

Special-T shall have the right to refuse or cancel any order placed for a product listed at the incorrect price. If an item's correct price is lower than our stated price, we will charge the lower amount and ship the item.

If an item's correct price is higher than our stated price, we will notify the price error for review and extend an opportunity to purchase the item at the correct price.

Freight Notifications

Minimum Freight Fee

FOB: Destination on table orders over \$5,000 List.

\$195 freight fee on orders less than \$5,000 List (Prepaid & Add) | Dock-to-Dock delivery.

Patriot Electric & Liberty Electric Bases Only

QTY: 1 - 3 \$55 each | 4-15 \$33 each | 16 - 50 \$27 each | 51 + \$16 each

FOB: Alpharetta, GA; PPD & ADD | Dock-to-Dock delivery.

Shipments Outside Continental U.S.

Qualified Freight Prepaid orders with final destination outside Continental U.S. will ship to the Freight Forwarder or Port of Embarkation within the 48 contiguous states. Shipments from Freight Forwarder/Port of Embarkation will ship FOB: Origin to final destination.

Oversize Fee

All LTL shipments for pallets 8' and over

96"-108" - additional \$250.00

109"-168" - additional \$350.00

Per custom pallet

GSA PRICE LIST

Effective
March 10, 2023

GS-28F-0014W
GS-28F-0015W

TABLE OF CONTENTS

GSA Terms and Conditions 06

GS-28F-0014W

BREAKROOM, CAFETERIA, & HOSPITALITY TABLES

AIM	08
ClassiX	09
Ella	10
Maxim	11
Quatro	12
Reveal	13
Robot	15
Sienna Round	16
Sienna Café Power	17
Sienna Square	18
Sienna X	19
Sienna X Café Power	20
Structure 4X	21
Success	22

GS-28F-0015W

TRAINING & TASK TABLES

AIM	24
Antonio	25
Apollo	27
Ella	29
EZ-Roll	32
Kingston	33
Quatro	36
Robot	38
Sienna TL	41
Structure 2T	42
Structure 2C	43
Structure H	44
Structure Square	45

FLIP AND NEST TABLES

Convertible	47
Kingston Flip	48
Kingston Flip-C	49
Kingston Flip Arched	50
Structure Flip Top-T	51
Structure Flip Top-C	52

CONFERENCE TABLES

AIM XL	54
Atlantis	59
Benton	62
Connect	65
Olympus	68
Sienna 2TL	72
Sienna 4X	74
Sienna Conference	75
Sienna Rectangle	78
Structure 4X	79
Structure Cube	81



GSA PRICE LIST

Effective
March 10, 2023

GS-28F-0014W
GS-28F-0015W

TABLE OF CONTENTS

HEIGHT ADJUSTABLE TABLES

Patriot Electric Table85
Patriot Electric Bases 90
Liberty Electric Table 91
Liberty Electric Bases93

ADDITIONAL INFORMATION

Standard Table Features 95
Warranty & Return Policy 97
Color Options 99

GSA TERMS & CONDITIONS



11820 Wills Road, Suite 140
Alpharetta, GA 30009-2056
Toll Free 888.705.0777 Local 678.879.0777
Fax 678.456.6046
www.specialT.net

GSA TERMS & CONDITIONS

GSA CONTRACTS

GS-28F-0014W (337127 CFSB & Order-Level Materials)

GS-28F-0015W (33721 & Order-Level Materials)

Contract Period: January 1, 2020 - December 31, 2024
Revised May 6, 2022

1A. Special Item Number:

SIN 33721 Tables & Accessories
SIN 337127 CFSB Cafeteria & Food
Service Furniture
SIN OLM Order-Level Materials

2. Maximum Order Limitation:

\$250,000 Net SIN 33721 Tables &
Accessories
\$250,000 Net SIN 337127 CFSB
Cafeteria & Food Service Furniture
\$250,000 Net SIN OLM Order-Level
Materials

3. Minimum Order:

\$100.00 Net

4. Geographic Coverage:

48 CONUS & Washington DC

5. Point of Production:

Alpharetta, GA 30009-2056

6. Discount:

57.3% off List (57.6% with 0.75% IFF)

7. Single Order Quantity Discounts:

None offered

8. Prompt Payment Terms:

Net 30

9A. Government Purchase Cards are
accepted at/or below the
Micro-Purchase Threshold.

9B. Government Purchase Cards
are Accepted at/or above the Micro-
Purchase Threshold

10. Foreign Terms:

Not available

11A. Time of Delivery:

45 - 90 Days A.R.O.

11B. Expedited Delivery:

One (1) and Five (5) Day items are
available and noted in the GSA and
Commercial Price Lists.

11C. Overnight and Two (2) Day Delivery:

Not applicable

11D. Urgent Requirements:

Contact factory

12. FOB Point:

Origin - Freight prepaid & allowed; Orders
under \$5,000 List (\$2,135 Net) are subject
to a \$195 Net minimum freight charge.
Patriot Electric & Liberty Electric Bases
Only QTY: 1 - 3 \$55 each | 4-15 \$33 each |
16 - 50 \$27 each | 51 + \$16 each
FOB: Alpharetta, GA; PPD & ADD | Dock
to Dock Delivery

13. Ordering Address:

Special-T, LLC
c/o Authorized Dealer (If applicable)
11820 Wills Road, Suite 140
Alpharetta, GA 30009-2056
Phone: 678.879.0777/888.705.0777
Fax: 678.456.6046
E-mail: orders@specialt.net

13B. Ordering procedures:

For supplies and services, the ordering
procedures and information on Blanket
Purchase Agreements (BPAs) are found
in Federal Acquisition Regulation (FAR)
8.405-3

14. Payment Address:

Same as ordering address

15. Warranty:

Special-T, LLC Warranty to the original
purchaser for a period of ten (10) years
from the date of delivery

16. Export Packing Charges:

Not applicable

17. Terms of Government Commercial Credit Card Acceptance:

Not applicable

18. Rental, Maintenance & Repairs Terms:

Not applicable

19. Installation Terms:

Contact factory or participating dealer

20. Repair Parts, etc.

See warranty

21. List of Service and Distribution Points:

Contact factory

22. List of Participating Dealers:

Contact factory

23. Preventive Maintenance:

Contact factory

24. Environmental Attributes:

In compliance

24A. Special Attributes such as Environmental Attributes

(e.g., Recycled Content, Energy Efficiency
and/or Reduced Pollutants)

24B. Section 508 Compliance:

Not applicable

25. Special-T LLC Information:

UEI: JN35LUM5XR97
DUNS: 078319819
FED ID: 81-2612288
CAGE Code: 5LB46

26. Notification Regarding Registration in System for Award Management (SAM) Database:

Registered

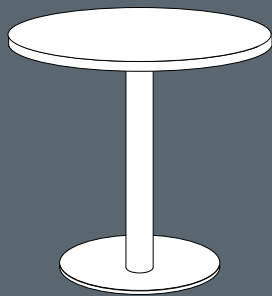

BREAKROOM, CAFETERIA, & HOSPITALITY TABLES

GS-28F-0014W

BREAKROOM, CAFETERIA, & HOSPITALITY TABLES

AIM

GS-28F-0014W

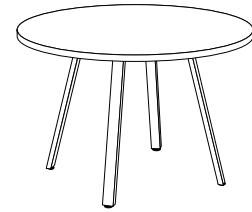

CONFIGURE & PRICE

	MODEL NUMBER	TFL	HPL	1-DAY	5-DAY
Round	AIM-36R	420.80	466.93	-	-
	AIM-42R	466.93	518.63	-	-
	AIM-48R	483.16	536.56	-	-
	AIM-54R	589.54	654.90	-	-
	AIM-60R	605.35	673.27	-	-
Square	AIM-3636	332.80	369.95	-	-
	AIM-4242	395.59	439.60	-	-
	AIM-4848	491.71	546.40	-	-
	AIM-5454	535.72	595.53	-	-
	AIM-6060	538.70	598.09	-	-

AIM Options

MODEL NUMBER	DESCRIPTION	ADD-ON
-CA-P	Cloud Casters	25.63
-BH	Bar Height 42"	25.63
-CH	Counter Height 36"	12.39

Accessories for Breakroom, Cafeteria, & Hospitality Tables

OPTION	DESCRIPTION	PRICE
Power & Data Management	Burele, EZ Power, Nacre, MhoB, Dean, Node, Ashley Duo Air, Villa, Cove, Interact G2	Visit SpecialT.net
Wire Management	J-Shape wire manager and table leg wire channel	

BREAKROOM, CAFETERIA, & HOSPITALITY TABLES

ClassiX

GS-28F-0014W



CONFIGURE & PRICE

	MODEL NUMBER	TFL	HPL	1-DAY	5-DAY
Round	CLSX-24	245.64	272.55	-	-
	CLSX-30	281.10	312.72	-	-
	CLSX-36	325.10	360.99	-	-
	CLSX-42	384.91	427.20	-	-
	CLSX-48	442.58	491.71	-	-
Square	CLSX-2424	234.11	260.59	-	-
	CLSX-3030	267.86	297.76	-	-
	CLSX-3636	306.73	341.34	-	-
	CLSX-4242	362.70	402.43	-	-
	CLSX-4848	414.39	460.10	-	-
Rectangle	CLSX-2430	267.86	297.76	-	-
	CLSX-2436	306.73	341.34	-	-
	CLSX-2442	360.99	401.99	-	-
	CLSX-2448	414.39	460.10	-	-
	CLSX-3036	306.73	341.34	-	-
	CLSX-3042	371.24	412.68	-	-
	CLSX-3048	431.90	480.18	-	-
	CLSX-3642	420.80	467.79	-	-
	CLSX-3648	463.09	514.78	-	-
	CLSX-4248	481.46	534.86	-	-

ClassiX Options

MODEL NUMBER	DESCRIPTION	ADD-ON
-42	Bar Height	26.91
-FT	Flip Top - Quick Flip	93.13
-CA	Casters	32.47
-SLG	Self Leveling Glides	35.89
-CUSTHT1	Custom Height between 5" - 28.99"	29.05
-CUSTHT2	Custom Height between 29" - 42"	55.96

Accessories for Breakroom, Cafeteria, & Hospitality Tables

OPTION	DESCRIPTION	PRICE
Power & Data Management	Burele, EZ Power, Nacre, MhoB, Dean, Node, Ashley Duo Air, Villa, Cove, Interact G2	Visit SpecialT.net
Wire Management	J-Shape wire manager and table leg wire channel	

BREAKROOM, CAFETERIA, & HOSPITALITY TABLES

Ella

GS-28F-0014W

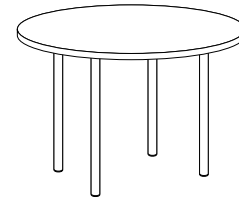

CONFIGURE & PRICE

	MODEL NUMBER	TFL	HPL	1-DAY	5-DAY
Round	ELLA-24	326.39	361.84	-	-
	ELLA-30	360.56	401.15	-	-
	ELLA-36	405.42	450.28	-	-
	ELLA-42	465.23	517.77	-	-
	ELLA-48	520.77	578.01	-	-
	ELLA-60	730.10	810.83	-	-
Square	ELLA-2424	315.71	349.88	-	-
	ELLA-3030	347.75	386.62	-	-
	ELLA-3636	386.62	429.76	-	-
	ELLA-4242	440.88	490.01	-	-
	ELLA-4848	492.56	547.24	-	-

Ella Options

MODEL NUMBER	DESCRIPTION	ADD-ON	
		TABLES UNDER 84" LONG	TABLES 84" & LONGER
-2	2" Diameter	-	-
-3	3" Diameter	61.52	92.28
-4	4" diameter	129.87	194.81
-FM	Folding Legs	269.99	404.99
-SLG	Self Leveling Glides	35.89	53.83
-CA	Casters	32.47	48.70
-42	Bar Height	107.66	161.48
-CUSTHT1	Custom Height between 5" - 28.99"	116.20	174.30
-CUSTHT2	Custom Height between 29" - 42"	223.85	335.78

Accessories for Breakroom, Cafeteria, & Hospitality Tables

OPTION	DESCRIPTION	PRICE
Power & Data Management	Burele, EZ Power, Nacre, MhoB, Dean, Node, Ashley Duo Air, Villa, Cove, Interact G2	Visit SpecialT.net
Wire Management	J-Shape wire manager and table leg wire channel	

BREAKROOM, CAFETERIA, & HOSPITALITY TABLES

Maxim

GS-28F-0014W

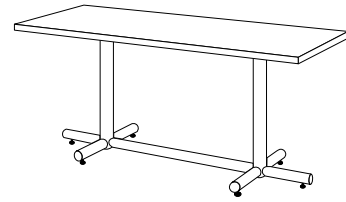

		CONFIGURE & PRICE			
Rectangle	MODEL NUMBER	TFL	HPL	1-DAY	5-DAY
	MAX-2460	384.06	426.78	-	-
	MAX-2466	528.88	586.98	-	-
	MAX-2472	549.38	610.90	-	-
	MAX-2484	650.21	722.40	-	-
	MAX-2496	710.87	789.05	-	-
	MAX-3060	560.92	623.29	-	-
	MAX-3066	578.01	642.94	-	-
	MAX-3072	611.76	679.68	-	-
	MAX-3084	749.74	833.47	-	-
	MAX-3096	815.96	906.53	-	-
	MAX-36108	1050.07	1,167.12	-	-
	MAX-36120	1171.40	1,300.41	-	-
	MAX-36144	1,402.09	1,557.16	-	-

Maxim Options

MODEL NUMBER	DESCRIPTION	ADD-ON	
		TABLES UP TO 84" LONG	TABLES 96" LONG
-42	Bar Height	53.83	80.74
-CUSTHT1	Custom Height between 5" - 28.99"	58.10	64.94
-CUSTHT2	Custom Height between 29" - 42"	111.93	71.77
-CA	Castors	48.70	87.15
-SLG	Self Leveling Glides	53.83	167.89

Accessories for Breakroom, Cafeteria, & Hospitality Tables

OPTION	DESCRIPTION	PRICE
Power & Data Management	Burele, EZ Power, Nacre, MhoB, Dean, Node, Ashley Duo Air, Villa, Cove, Interact G2	Visit SpecialT.net
Wire Management	J-Shape wire manager and table leg wire channel	

*An Oversize Fee has been implemented by freight carriers for all LTL shipments for pallets 8' and over. 96"-108" - additional \$250.00 | 109" -168" - additional \$350.00 | Per custom pallet

BREAKROOM, CAFETERIA, & HOSPITALITY TABLES

Quatro

GS-28F-0014W

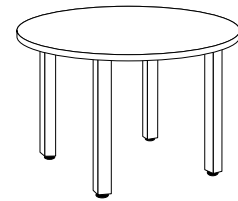

CONFIGURE & PRICE

	MODEL NUMBER	TFL	HPL	1-DAY	5-DAY
Round	QUAT-24	329.80	366.12	-	-
	QUAT-30	366.12	407.12	-	-
	QUAT-36	410.12	455.40	-	-
	QUAT-42	469.50	521.19	-	-
	QUAT-48	525.04	583.56	-	-
Square	QUAT-2424	318.27	354.16	-	-
	QUAT-3030	349.88	389.18	-	-
	QUAT-3636	390.04	433.61	-	-
	QUAT-4242	445.15	493.42	-	-
	QUAT-4848	496.41	551.52	-	-

Quatro Options

MODEL NUMBER	DESCRIPTION	ADD-ON
-CA	Casters	32.47
-42	Bar Height	107.66
-CUSTHT1	Custom Height between 5" - 28.99"	116.20
-CUSTHT2	Custom Height between 29" - 42"	223.85

Accessories for Breakroom, Cafeteria, & Hospitality Tables

OPTION	DESCRIPTION	PRICE
Power & Data Management	Burele, EZ Power, Nacre, MhoB, Dean, Node, Ashley Duo Air, Villa, Cove, Interact G2	Visit SpecialT.net
Wire Management	J-Shape wire manager and table leg wire channel	

BREAKROOM, CAFETERIA, & HOSPITALITY TABLES

Reveal

GS-28F-0014W

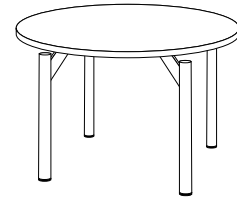

CONFIGURE & PRICE

	MODEL NUMBER	TFL	HPL	1-DAY	5-DAY
Round	REVL-24	365.68	406.27	-	-
	REVL-30	401.99	446.43	-	-
	REVL-36	441.73	491.71	-	-
	REVL-42	498.12	553.65	-	-
	REVL-48	559.21	621.58	-	-
Square	REVL-2424	349.88	389.18	-	-
	REVL-3030	387.90	430.62	-	-
	REVL-3636	424.21	471.20	-	-
	REVL-4242	479.32	533.15	-	-
	REVL-4848	535.28	595.09	-	-
Rectangle	REVL-1824	298.62	332.36	-	-
	REVL-1830	308.44	342.62	-	-
	REVL-1836	320.83	355.44	-	-
	REVL-1842	333.22	370.39	-	-
	REVL-1848	351.59	390.04	-	-
	REVL-1854	359.71	399.44	-	-
	REVL-1860	368.25	409.69	-	-
	REVL-1866	402.43	447.28	-	-
	REVL-1872	421.65	468.21	-	-
	REVL-1878	472.06	524.18	-	-
	REVL-1884	523.75	581.42	-	-
	REVL-1896	558.36	620.30	-	-
	REVL-2430	326.39	361.84	-	-
	REVL-2436	337.49	375.08	-	-
	REVL-2442	354.16	393.45	-	-
	REVL-2448	368.25	409.69	-	-
	REVL-2454	382.77	424.64	-	-
	REVL-2460	396.44	440.44	-	-
	REVL-2466	441.73	491.71	-	-
	REVL-2472	464.37	515.64	-	-
REVL-2478	504.52	560.92	-	-	
REVL-2484	545.96	605.77	-	-	
REVL-2496	593.81	660.03	-	-	

BREAKROOM, CAFETERIA, & HOSPITALITY TABLES

Reveal

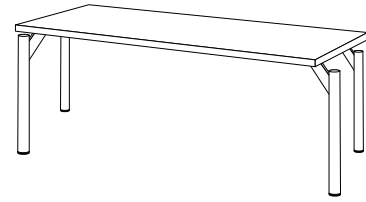

GS-28F-0014W

CONFIGURE & PRICE

	MODEL NUMBER	TFL	HPL	1-DAY	5-DAY
Rectangle	REVL-3042	376.80	417.80	-	-
	REVL-3048	396.44	440.44	-	-
	REVL-3054	419.94	466.51	-	-
	REVL-3060	441.73	491.28	-	-
	REVL-3066	483.16	536.56	-	-
	REVL-3072	514.78	571.60	-	-
	REVL-3078	577.15	641.23	-	-
	REVL-3084	638.67	709.16	-	-
	REVL-3096	678.40	753.16	-	-
	REVL-3642	420.80	467.37	-	-
	REVL-3648	441.73	491.28	-	-
	REVL-3654	467.37	519.05	-	-
	REVL-3660	495.56	549.81	-	-
	REVL-3666	558.36	620.30	-	-
	REVL-3672	576.73	640.38	-	-
	REVL-3678	628.41	698.48	-	-
	REVL-3684	683.53	758.71	-	-
	REVL-3696	722.83	803.14	-	-

Reveal Options

MODEL NUMBER	DESCRIPTION	ADD-ON
-SLG	Self Leveling Glides	35.89
-CUSTHT1	Custom Height between 5" - 28.99"	116.20

Accessories for Breakroom, Cafeteria, & Hospitality Tables

OPTION	DESCRIPTION	PRICE
Power & Data Management	Burele, EZ Power, Nacre, MhoB, Dean, Node, Ashley Duo Air, Villa, Cove, Interact G2	Visit SpecialT.net
Wire Management	J-Shape wire manager and table leg wire channel	

*An Oversize Fee has been implemented by freight carriers for all LTL shipments for pallets 8' and over. 96"-108" - additional \$250.00 | 109" -168" - additional \$350.00 | Per custom pallet

BREAKROOM, CAFETERIA, & HOSPITALITY TABLES

Robot

GS-28F-0014W

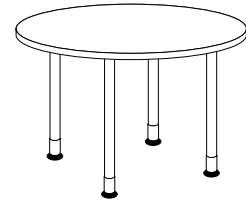

CONFIGURE & PRICE

	MODEL NUMBER	TFL	HPL	1-DAY	5-DAY
Round	ROBT-24	329.80	365.68	-	-
	ROBT-30	365.68	406.27	-	-
	ROBT-36	410.12	455.40	-	-
	ROBT-42	469.50	521.19	-	-
	ROBT-48	525.88	584.41	-	-
Square	ROBT-2424	318.27	354.16	-	-
	ROBT-3030	349.88	389.18	-	-
	ROBT-3636	409.69	454.97	-	-
	ROBT-4242	469.50	521.19	-	-
	ROBT-4848	525.04	583.56	-	-

Robot Options

MODEL NUMBER	DESCRIPTION	ADD-ON
-SC	Skate Casters	-
-AH	Adjustable Height	54.68
-CUSTHT1	Custom Height between 5" - 28.99"	116.20

Accessories for Breakroom, Cafeteria, & Hospitality Tables

OPTION	DESCRIPTION	PRICE
Power & Data Management	Burele, EZ Power, Nacre, MhoB, Dean, Node, Ashley Duo Air, Villa, Cove, Interact G2	Visit SpecialT.net
Wire Management	J-Shape wire manager and table leg wire channel	

BREAKROOM, CAFETERIA, & HOSPITALITY TABLES
Sienna Round

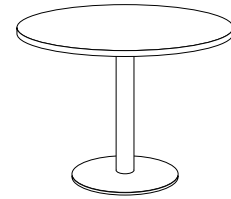

GS-28F-0014W

CONFIGURE & PRICE

	MODEL NUMBER	TFL	HPL	1-DAY	5-DAY
Round	SIEN-24	313.57	348.59	-	-
	SIEN-30	329.80	365.68	-	-
	SIEN-36	359.71	399.44	-	-
	SIEN-42	484.88	538.70	-	-
	SIEN-48	507.52	563.91	-	-
Square	SIEN-2424	345.18	383.63	-	-
	SIEN-3030	370.81	411.83	-	-
	SIEN-3636	441.30	490.43	-	-
	SIEN-4242	476.76	529.73	-	-
	SIEN-4848	498.97	554.51	-	-

Sienna Round Options

MODEL NUMBER	DESCRIPTION	ADD-ON
-42	Bar Height Option	26.91
-CUSTHT1	Custom Height between 5" - 28.99"	29.05
-CUSTHT2	Custom Height between 29" - 42"	55.96
-FR	Foot Ring	44.43

Accessories for Breakroom, Cafeteria, & Hospitality Tables

OPTION	DESCRIPTION	PRICE
Power & Data Management	Burele, EZ Power, Nacre, MhoB, Dean, Node, Ashley Duo Air, Villa, Cove, Interact G2	Visit SpecialT.net
Wire Management	J-Shape wire manager and table leg wire channel	

BREAKROOM, CAFETERIA, & HOSPITALITY TABLES

Sienna Café Power

GS-28F-0014W

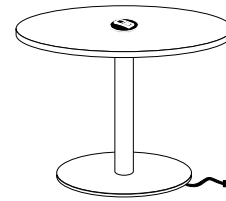

		CONFIGURE & PRICE			
	MODEL NUMBER	TFL	HPL	1-DAY	5-DAY
Round	SIEN-CP-30	778.79	778.79	-	-
	SIEN-CP-36	831.34	831.34	-	-
	SIEN-CP-42	991.11	991.11	-	-
	SIEN-CP-48	911.66	1,013.33	-	-
Square	SIEN-CP-3030	618.59	688.22	-	-
	SIEN-CP-3636	655.76	729.24	-	-
	SIEN-CP-4242	804.86	894.57	-	-
	SIEN-CP-4848	813.82	903.96	-	-

Sienna Café Power Options

MODEL NUMBER	DESCRIPTION	ADD-ON
-42	Bar Height Option	26.91
-CUSTHT1	Custom Height between 5" - 28.99"	29.05
-CUSTHT2	Custom Height between 29" - 42"	55.96

Accessories for Breakroom, Cafeteria, & Hospitality Tables

OPTION	DESCRIPTION	PRICE
Power & Data Management	Burele, EZ Power, Nacre, MhoB, Dean, Node, Ashley Duo Air, Villa, Cove, Interact G2	Visit SpecialT.net
Wire Management	J-Shape wire manager and table leg wire channel	

BREAKROOM, CAFETERIA, & HOSPITALITY TABLES

Sienna Square

GS-28F-0014W

CONFIGURE & PRICE

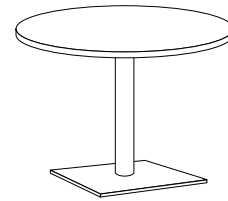

	MODEL NUMBER	TFL	HPL	1-DAY	5-DAY
Round	SIENS-24	313.57	348.59	-	-
	SIENS-30	329.80	365.68	-	-
	SIENS-36	359.71	399.44	-	-
	SIENS-42	484.88	538.70	-	-
	SIENS-48	507.52	563.91	-	-
Square	SIENS-2424	345.18	383.63	-	-
	SIENS-3030	370.81	411.83	-	-
	SIENS-3636	441.30	490.43	-	-
	SIENS-4242	476.76	529.73	-	-
	SIENS-4848	498.97	554.51	-	-

Sienna Square Options

MODEL NUMBER	DESCRIPTION	ADD-ON
-42	Bar Height Option	26.91
-CUSTHT1	Custom Height between 5" - 28.99"	29.05
-CUSTHT2	Custom Height between 29" - 42"	55.96
-FR	Foot Ring	44.43

Accessories for Breakroom, Cafeteria, & Hospitality Tables

OPTION	DESCRIPTION	PRICE
Power & Data Management	Burele, EZ Power, Nacre, MhoB, Dean, Node, Ashley Duo Air, Villa, Cove, Interact G2	Visit SpecialT.net
Wire Management	J-Shape wire manager and table leg wire channel	

BREAKROOM, CAFETERIA, & HOSPITALITY TABLES

Sienna X

GS-28F-0014W

CONFIGURE & PRICE

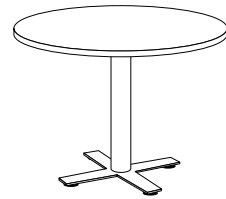

	MODEL NUMBER	TFL	HPL	1-DAY	5-DAY
Round	SIENX-30	355.44	395.59	-	-
	SIENX-36	424.64	472.06	-	-
	SIENX-42	515.20	572.45	-	-
Square	SIENX-3030	343.90	382.77	-	-
	SIENX-3636	408.40	453.26	-	-
	SIENX-4242	495.13	549.38	-	-

Sienna X Options

MODEL NUMBER	DESCRIPTION	ADD-ON
-42	Bar Height Option	26.91
-CUSTHT1	Custom Height between 5" - 28.99"	29.05
-CUSTHT2	Custom Height between 29" - 42"	55.96
-FR	Foot Ring	44.43

Accessories for Breakroom, Cafeteria, & Hospitality Tables

OPTION	DESCRIPTION	PRICE
Power & Data Management	Burele, EZ Power, Nacre, MhoB, Dean, Node, Ashley Duo Air, Villa, Cove, Interact G2	Visit SpecialT.net
Wire Management	J-Shape wire manager and table leg wire channel	

BREAKROOM, CAFETERIA, & HOSPITALITY TABLES

Sienna X Café Power

GS-28F-0014W

CONFIGURE & PRICE

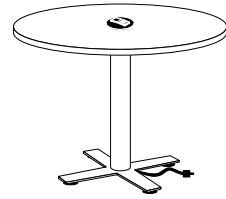

	MODEL NUMBER	TFL	HPL	1-DAY	5-DAY
Round	SIENX-CP-30	701.47	778.79	-	-
	SIENX-CP-36	777.09	862.53	-	-
	SIENX-CP-42	915.50	1,016.32	-	-
Square	SIENX-CP-3030	618.59	688.22	-	-
	SIENX-CP-3636	684.38	760.00	-	-
	SIENX-CP-4242	827.92	918.91	-	-

Sienna X Café Power Options

MODEL NUMBER	DESCRIPTION	ADD-ON
-42	Bar Height Option	26.91
-CUSTHT1	Custom Height between 5" - 28.99"	29.05
-CUSTHT2	Custom Height between 29" - 42"	55.96
-FR	Foot Ring	44.43

Accessories for Breakroom, Cafeteria, & Hospitality Tables

OPTION	DESCRIPTION	PRICE
Power & Data Management	Burele, EZ Power, Nacre, MhoB, Dean, Node, Ashley Duo Air, Villa, Cove, Interact G2	Visit SpecialT.net
Wire Management	J-Shape wire manager and table leg wire channel	

BREAKROOM, CAFETERIA, & HOSPITALITY TABLES

Structure 4X

GS-28F-0014W

[CONFIGURE & PRICE](#)



	MODEL NUMBER	TFL	HPL	1-DAY	5-DAY
	29" H				
Round	STRU-4X-24	307.59	341.34	-	-
	STRU-4X-30	349.88	389.18	-	-
	STRU-4X-36	409.69	454.97	-	-
	STRU-4X-42	483.16	536.56	-	-
Square	STRU-4X-2424	355.00	394.74	-	-
	STRU-4X-3030	427.63	474.62	-	-
	STRU-4X-3636	474.62	528.02	-	-
	STRU-4X-4242	566.05	628.41	-	-

Structure 4X Options

MODEL NUMBER	DESCRIPTION	ADD-ON
-42	Bar Height 42"	27.34
-OH	Occasional Height 16"	-21.79

Accessories for Breakroom, Cafeteria, & Hospitality Tables

OPTION	DESCRIPTION	PRICE
Power & Data Management	Burele, EZ Power, Nacre, MhoB, Dean, Node, Ashley Duo Air, Villa, Cove, Interact G2	Visit SpecialT.net
Wire Management	J-Shape wire manager and table leg wire channel	

BREAKROOM, CAFETERIA, & HOSPITALITY TABLES

Success

GS-28F-0014W

CONFIGURE & PRICE

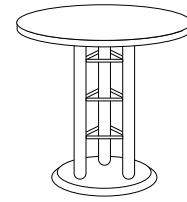

	MODEL NUMBER	TFL	HPL	1-DAY	5-DAY
Round	SCSS-24	405.84	451.12	-	-
	SCSS-30	441.73	491.28	-	-
	SCSS-36	520.33	577.58	-	-
	SCSS-42	622.86	692.07	-	-
Square	SCSS-2424	394.74	438.74	-	-
	SCSS-3030	427.63	474.62	-	-
	SCSS-3636	500.25	555.79	-	-
	SCSS-4242	598.94	665.58	-	-

Success Options

MODEL NUMBER	DESCRIPTION	ADD-ON
-42	Bar Height	38.88
-CUSTHT1	Custom Height between 5" - 28.99"	87.15
-CUSTHT2	Custom Height between 29" - 42"	126.03

Accessories for Breakroom, Cafeteria, & Hospitality Tables

OPTION	DESCRIPTION	PRICE
Power & Data Management	Burele, EZ Power, Nacre, MhoB, Dean, Node, Ashley Duo Air, Villa, Cove, Interact G2	Visit SpecialT.net
Wire Management	J-Shape wire manager and table leg wire channel	

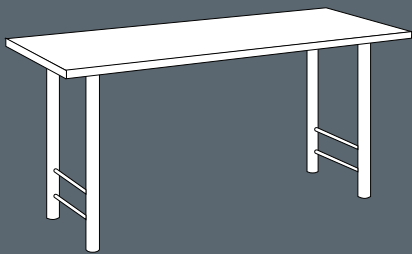

TRAINING & TASK TABLES

GS-28F-0015W

TRAINING & TASK TABLES

AIM

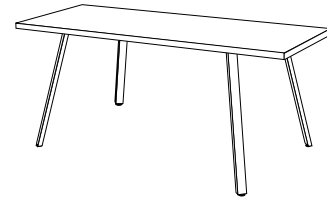

GS-28F-0015W

		CONFIGURE & PRICE			
	MODEL NUMBER	TFL	HPL	1-DAY	5-DAY
Rectangle	AIM-2448	375.94	417.80	-	-
	AIM-2454	398.16	441.73	-	-
	AIM-2460	401.57	446.01	-	-
	AIM-2466	427.63	475.91	-	-
	AIM-2472	465.23	517.77	-	-
	AIM-3048	419.94	466.51	-	-
	AIM-3054	424.21	471.20	-	-
	AIM-3060	427.63	475.91	-	-
	AIM-3066	493.00	548.53	-	-
	AIM-3072	501.54	557.08	-	-
	AIM-3648	512.22	569.46	-	-
	AIM-3654	561.35	623.72	-	-
	AIM-3660	566.47	628.85	-	-
	AIM-3666	643.80	715.57	-	-
	AIM-3672	649.35	721.12	-	-

AIM Options

MODEL NUMBER	DESCRIPTION	ADD-ON
-CA-P	Cloud Casters	25.63
-BH	Bar Height 42"	25.63
-CH	Counter Height 36"	12.39

Accessories for Training & Task Tables

OPTION	DESCRIPTION	PRICE
Modesty Panels	Perforated steel, laminate, Acrylite modesty panel and removable laminate for folding option	Visit SpecialT.net
Privacy Screens	Acrylite Privacy Screens	
Grommets	Round or Rectangle	
Power & Data Management	Burele, EZ Power, Nacre, MhoB, Dean, Node, Ashley Duo Air, Villa, Cove, Interact G2	
Wire Management	J-Shape wire manager and table leg wire channel	
Table Connector	Quick Align	

TRAINING & TASK TABLES

Antonio

GS-28F-0015W

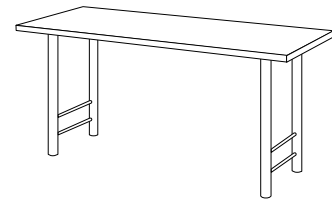

		CONFIGURE & PRICE				
		MODEL NUMBER	TFL	HPL	1-DAY	5-DAY
Rectangle	ANTO-2430	302.46	336.21	-	-	
	ANTO-2436	314.42	349.45	-	-	
	ANTO-2442	321.26	355.86	-	-	
	ANTO-2448	335.36	372.95	-	-	
	ANTO-2454	347.75	386.62	-	-	
	ANTO-2460	360.56	401.15	-	-	
	ANTO-2466	405.42	450.28	-	-	
	ANTO-2472	426.35	473.34	-	-	
	ANTO-2478	446.43	496.41	-	-	
	ANTO-2484	502.82	558.78	-	-	
	ANTO-2496	548.10	608.77	-	-	
	ANTO-3042	350.73	389.61	-	-	
	ANTO-3048	370.39	411.40	-	-	
	ANTO-3054	391.31	434.89	-	-	
	ANTO-3060	414.39	459.24	-	-	
	ANTO-3066	451.98	501.96	-	-	
	ANTO-3072	481.46	535.28	-	-	
	ANTO-3078	518.63	576.30	-	-	
	ANTO-3084	598.94	665.58	-	-	
	ANTO-3096	636.96	707.45	-	-	
Trapezoid	ANTO-2448-TRA	347.75	386.62	-	-	
	ANTO-2460-TRA	375.94	417.38	-	-	
	ANTO-2472-TRA	443.87	492.56	-	-	
	ANTO-3048-TRA	384.06	426.78	-	-	
	ANTO-3060-TRA	431.05	478.89	-	-	
	ANTO-3072-TRA	502.82	558.78	-	-	

TRAINING & TASK TABLES

Antonio

GS-28F-0015W

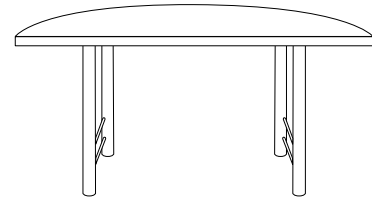

		CONFIGURE & PRICE				
	MODEL NUMBER	TFL	HPL	1-DAY	5-DAY	
1/2 Round	ANTO-3060-HRD	483.60	537.00	-	-	
	ANTO-3672-HRD	598.51	781.78	-	-	
1/4 Round	ANTO-3030-QRD	399.01	442.58	-	-	
	ANTO-3636-QRD	444.72	493.00	-	-	
Crescent	ANTO-2472-CRE	566.90	629.27	-	-	
	ANTO-2494-CRE	789.05	877.05	-	-	
	ANTO-3072-CRE	575.87	639.09	-	-	
	ANTO-3094-CRE	798.02	886.03	-	-	

Antonio Options

MODEL NUMBER	DESCRIPTION	ADD-ON
-CA	Casters	32.47
-42	Bar Height	107.66
-36	Counter Height	107.66
-CUSTHT1	Custom Height between 5" - 28.99"	116.20
-CUSTHT2	Custom Height between 29" - 42"	223.85

Accessories for Training & Task Tables

OPTION	DESCRIPTION	PRICE
Modesty Panels	Perforated steel, laminate, Acrylite modesty panel and removable laminate for folding option	Visit SpecialT.net
Privacy Screens	Acrylite Privacy Screens	
Grommets	Round or Rectangle	
Power & Data Management	Burele, EZ Power, Nacre, MhoB, Dean, Node, Ashley Duo Air, Villa, Cove, Interact G2	
Wire Management	J-Shape wire manager and table leg wire channel	
Table Connector	Quick Align	

*An Oversize Fee has been implemented by freight carriers for all LTL shipments for pallets 8' and over.
96"-108" - additional \$250.00 | 109"-168" - additional \$350.00 | Per custom pallet

TRAINING & TASK TABLES

Apollo

GS-28F-0015W

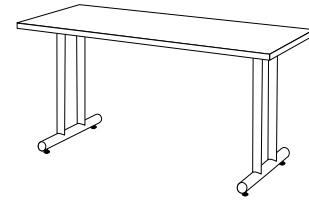

CONFIGURE & PRICE

	MODEL NUMBER	TFL	HPL	1-DAY	5-DAY
Rectangle	APOL-2436	358.85	398.58	-	-
	APOL-2442	373.80	415.67	-	-
	APOL-2448	387.90	430.62	-	-
	APOL-2454	400.29	445.15	-	-
	APOL-2460	414.39	460.52	-	-
	APOL-2466	457.96	508.80	-	-
	APOL-2472	478.47	531.01	-	-
	APOL-2478	516.06	574.59	-	-
	APOL-2484	554.51	616.89	-	-
	APOL-2496	599.80	666.86	-	-
	APOL-3042	396.02	440.02	-	-
	APOL-3048	414.39	460.52	-	-
	APOL-3054	435.32	483.60	-	-
	APOL-3060	457.53	508.37	-	-
	APOL-3066	496.41	551.52	-	-
	APOL-3072	525.88	584.41	-	-
	APOL-3078	583.56	648.49	-	-
	APOL-3084	642.52	713.85	-	-
	APOL-3096	679.68	755.29	-	-
	APOL-3642	436.17	485.30	-	-
APOL-3648	457.53	508.37	-	-	
APOL-3654	484.02	537.85	-	-	
Trapezoid	APOL-2460-TRA	468.21	519.91	-	-
	APOL-2472-TRA	538.70	598.51	-	-
	APOL-3048-TRA	476.76	529.73	-	-
	APOL-3060-TRA	526.32	585.69	-	-
	APOL-3072-TRA	601.08	668.15	-	-

TRAINING & TASK TABLES

Apollo

GS-28F-0015W

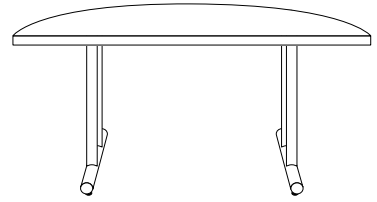

CONFIGURE & PRICE

	MODEL NUMBER	TFL	HPL	1-DAY	5-DAY
1/2 Round	APOL-6030-HRD	582.28	646.79	-	-
	APOL-7236-HRD	703.61	781.78	-	-
1/4 Round	APOL-3030-QRD	492.56	547.24	-	-
	APOL-3636-QRD	539.99	599.80	-	-
Crescent	APOL-2472-CRE	654.90	726.67	-	-
	APOL-2494-CRE	889.44	987.70	-	-
	APOL-3072-CRE	663.45	736.50	-	-
	APOL-3094-CRE	898.84	998.38	-	-

Apollo Options

MODEL NUMBER	DESCRIPTION	ADD-ON
-TL	T-Leg Option	-
-CL	C-Leg Option	-
-CA	Casters	32.47
-42	Bar Height	107.66
-36	Counter Height	107.66
-CUSTHT1	Custom Height between 5" - 28.99"	116.20
-CUSTHT2	Custom Height between 29" - 42"	223.85

Accessories for Training & Task Tables

OPTION	DESCRIPTION	PRICE
Modesty Panels	Perforated steel, laminate, Acrylite modesty panel and removable laminate for folding option	Visit SpecialT.net
Privacy Screens	Acrylite Privacy Screens	
Grommets	Round or Rectangle	
Power & Data Management	Burele, EZ Power, Nacre, MhoB, Dean, Node, Ashley Duo Air, Villa, Cove, Interact G2	
Wire Management	J-Shape wire manager and table leg wire channel	
Table Connector	Quick Align	

*An Oversize Fee has been implemented by freight carriers for all LTL shipments for pallets 8' and over.
96"-108" - additional \$250.00 | 109" -168" - additional \$350.00 | Per custom pallet

TRAINING & TASK TABLES

Ella

GS-28F-0015W

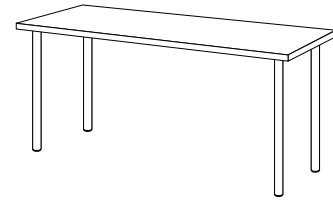

CONFIGURE & PRICE

	MODEL NUMBER	CONFIGURE & PRICE		1-DAY	5-DAY
		TFL	HPL		
Rectangle	ELLA-1824	251.19	278.54	-	-
	ELLA-1830	260.59	290.08	-	-
	ELLA-1836	266.15	296.05	-	-
	ELLA-1842	281.10	312.72	-	-
	ELLA-1848	298.62	332.36	-	-
	ELLA-1854	308.44	342.62	-	-
	ELLA-1860	316.55	351.59	-	-
	ELLA-1866	349.88	389.18	-	-
	ELLA-1872	370.39	411.40	-	-
	ELLA-1878	420.80	467.37	-	-
	ELLA-1884	470.78	523.32	-	-
	ELLA-1896	504.96	561.35	-	-
	ELLA-2430	276.83	308.01	-	-
	ELLA-2436	288.36	320.83	-	-
	ELLA-2442	302.04	335.36	-	-
	ELLA-2448	316.55	351.59	-	-
	ELLA-2454	330.23	367.40	-	-
	ELLA-2460	345.18	383.63	-	-
	ELLA-2466	390.89	434.47	-	-
	ELLA-2472	414.39	459.24	-	-
	ELLA-2478	453.26	504.10	-	-
	ELLA-2484	493.00	548.53	-	-
	ELLA-2496	541.27	601.08	-	-
	ELLA-3036	308.87	343.04	-	-
	ELLA-3042	324.25	360.56	-	-
	ELLA-3048	345.18	383.63	-	-
	ELLA-3054	367.82	408.40	-	-
	ELLA-3060	390.04	433.61	-	-
	ELLA-3066	427.63	474.62	-	-
	ELLA-3072	462.66	514.36	-	-
ELLA-3078	524.60	582.71	-	-	
ELLA-3084	586.13	651.49	-	-	
ELLA-3096	625.85	695.06	-	-	

TRAINING & TASK TABLES

Ella

GS-28F-0015W

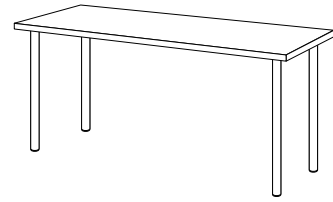

CONFIGURE & PRICE

	MODEL NUMBER	TFL	HPL	1-DAY	5-DAY
Rectangle	ELLA-3642	368.68	410.12	-	-
	ELLA-3648	390.04	433.61	-	-
	ELLA-3654	416.95	463.52	-	-
	ELLA-3660	443.87	493.00	-	-
	ELLA-3666	505.81	561.77	-	-
	ELLA-3672	524.60	582.71	-	-
	ELLA-3678	577.15	641.66	-	-
	ELLA-3684	629.27	699.76	-	-
	ELLA-3696	670.71	745.47	-	-
Trapezoid	ELLA-1848-TRA	311.86	345.61	-	-
	ELLA-1860-TRA	329.80	365.68	-	-
	ELLA-1872-TRA	385.34	428.48	-	-
	ELLA-2448-TRA	329.80	365.68	-	-
	ELLA-2460-TRA	359.27	399.01	-	-
	ELLA-2472-TRA	430.62	478.47	-	-
	ELLA-3048-TRA	359.27	399.01	-	-
	ELLA-3060-TRA	409.69	454.97	-	-
	ELLA-3072-TRA	485.30	538.70	-	-
1/2 Round	ELLA-3618-HRD	314.42	349.45	-	-
	ELLA-4824-HRD	375.52	416.95	-	-
	ELLA-6030-HRD	463.94	515.20	-	-
	ELLA-7236-HRD	586.55	651.49	-	-
1/4 Round	ELLA-1818-QRD	241.37	267.86	-	-
	ELLA-2424-QRD	260.17	288.36	-	-
	ELLA-3030-QRD	301.60	333.64	-	-
	ELLA-3636-QRD	349.88	388.76	-	-
Crescent	ELLA-1872-CRE	546.40	606.21	-	-
	ELLA-1894-CRE	781.78	867.65	-	-
	ELLA-2472-CRE	546.40	606.21	-	-
	ELLA-2494-CRE	781.78	867.65	-	-
	ELLA-3072-CRE	546.40	606.21	-	-
	ELLA-3094-CRE	781.78	867.65	-	-

TRAINING & TASK TABLES

Ella

GS-28F-0015W

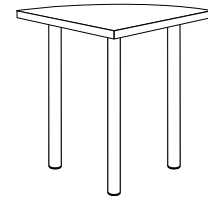

Ella Options

MODEL NUMBER	DESCRIPTION	ADD-ON	
		TABLES UNDER 84" LONG	TABLES 84" & LONGER
-2	2" Diameter	-	-
-3	3" Diameter	61.52	92.28
-4	4" diameter	129.87	194.81
-FM	Folding Legs	269.99	404.99
-SLG	Self Leveling Glides	35.89	53.83
-CA	Casters	32.47	48.70
-42	Bar Height	107.66	161.48
-CUSTHT1	Custom Height between 5" - 28.99"	116.20	174.30
-CUSTHT2	Custom Height between 29" - 42"	223.85	335.78

Accessories for Training & Task Tables

OPTION	DESCRIPTION	PRICE
Modesty Panels	Perforated steel, laminate, Acrylite modesty panel and removable laminate for folding option	Visit SpecialT.net
Privacy Screens	Acrylite Privacy Screens	
Grommets	Round or Rectangle	
Power & Data Management	Burele, EZ Power, Nacre, MhoB, Dean, Node, Ashley Duo Air, Villa, Cove, Interact G2	
Wire Management	J-Shape wire manager and table leg wire channel	
Table Connector	Quick Align	

*An Oversize Fee has been implemented by freight carriers for all LTL shipments for pallets 8' and over.
96"-108" - additional \$250.00 | 109" -168" - additional \$350.00 | Per custom pallet

TRAINING & TASK TABLES

EZ-Roll

GS-28F-0015W

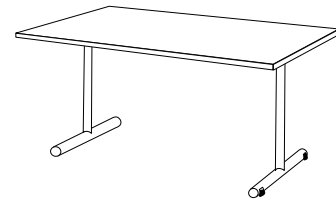

CONFIGURE & PRICE

	MODEL NUMBER	TFL	HPL	1-DAY	5-DAY
Rectangle	EZRL-1824	290.08	322.12	-	-
	EZRL-1830	297.33	330.23	-	-
	EZRL-1836	304.17	338.35	-	-
	EZRL-1842	306.31	340.05	-	-
	EZRL-1848	322.54	358.43	-	-
	EZRL-1854	328.95	365.68	-	-
	EZRL-1860	337.07	375.08	-	-
	EZRL-1866	368.68	408.84	-	-
	EZRL-1872	387.04	430.20	-	-
	EZRL-1878	437.03	486.59	-	-
	EZRL-2430	305.45	339.63	-	-
	EZRL-2436	316.55	351.59	-	-
	EZRL-2442	323.82	360.13	-	-
	EZRL-2448	337.07	375.08	-	-
	EZRL-2454	350.73	389.61	-	-
	EZRL-2460	363.55	403.71	-	-
	EZRL-2466	405.42	450.28	-	-
	EZRL-2472	425.92	472.92	-	-
	EZRL-2478	459.24	510.09	-	-
	EZRL-3042	344.76	383.63	-	-
	EZRL-3048	363.55	403.71	-	-
	EZRL-3054	384.06	426.35	-	-
	EZRL-3060	404.99	449.84	-	-
	EZRL-3066	442.58	491.28	-	-
EZRL-3072	471.20	523.32	-	-	
EZRL-3078	520.33	577.58	-	-	

EZ-Roll Options

MODEL NUMBER	DESCRIPTION	ADD-ON
-CUSTHT1	Custom Height between 5" - 28.99"	58.10

Accessories for Training & Task Tables

OPTION	DESCRIPTION	PRICE
Modesty Panels	Perforated steel, laminate, Acrylite modesty panel and removable laminate for folding option	Visit SpecialT.net
Privacy Screens	Acrylite Privacy Screens	
Grommets	Round or Rectangle	
Power & Data Management	Burele, EZ Power, Nacre, MhoB, Dean, Node, Ashley Duo Air, Villa, Cove, Interact G2	
Wire Management	J-Shape wire manager and table leg wire channel	
Table Connector	Quick Align	

TRAINING & TASK TABLES

Kingston

GS-28F-0015W

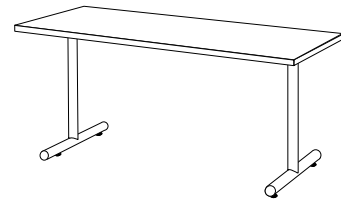

CONFIGURE & PRICE

	MODEL NUMBER	TFL	HPL	1-DAY	5-DAY
Rectangle	KING-1824	260.17	288.36	-	-
	KING-1830	267.86	297.76	-	-
	KING-1836	275.12	305.45	-	-
	KING-1842	287.94	320.83	-	-
	KING-1848	304.17	338.35	-	-
	KING-1854	312.28	347.31	-	-
	KING-1860	320.83	355.00	-	-
	KING-1866	351.59	390.04	-	-
	KING-1872	369.53	410.97	-	-
	KING-1878	405.84	450.70	-	-
	KING-1884	460.52	511.79	-	-
	KING-1896	491.71	546.40	-	-
	KING-18108	648.49	720.26	-	-
	KING-18120	713.43	792.04	-	-
	KING-2430	288.36	321.26	-	-
	KING-2436	299.90	333.22	-	-
	KING-2442	306.73	340.48	-	-
	KING-2448	320.83	355.00	-	-
	KING-2454	333.22	369.95	-	-
	KING-2460	345.18	384.06	-	-
	KING-2466	387.90	430.62	-	-
	KING-2472	408.40	453.69	-	-
	KING-2478	426.78	474.62	-	-
	KING-2484	481.03	534.43	-	-
	KING-2496	525.46	583.56	-	-
	KING-24108	680.53	756.15	-	-
	KING-24120	734.79	815.96	-	-
	KING-3042	327.23	363.55	-	-
	KING-3048	345.18	384.06	-	-
	KING-3054	365.68	406.27	-	-
KING-3060	387.04	430.20	-	-	
KING-3066	424.64	471.64	-	-	
KING-3072	453.26	504.10	-	-	
KING-3078	488.73	543.41	-	-	
KING-3084	565.62	628.41	-	-	

TRAINING & TASK TABLES

Kingston

GS-28F-0015W

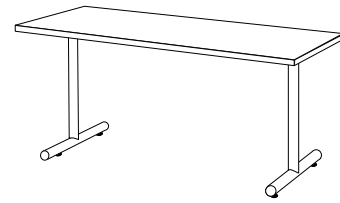

CONFIGURE & PRICE

	MODEL NUMBER	TFL	HPL	1-DAY	5-DAY
Rectangle	KING-3096	601.50	669.00	-	-
	KING-30108	743.34	825.36	-	-
	KING-30120	810.83	901.40	-	-
	KING-3642	367.40	407.56	-	-
	KING-3648	387.04	430.20	-	-
	KING-3654	405.42	450.28	-	-
	KING-3660	435.75	484.02	-	-
	KING-3666	491.71	546.40	-	-
	KING-3672	509.23	565.62	-	-
	KING-3678	567.32	629.70	-	-
	KING-3684	605.77	673.27	-	-
	KING-3696	642.52	713.85	-	-
Trapezoid	KING-1848-TRA	315.71	350.31	-	-
	KING-1860-TRA	332.80	369.53	-	-
	KING-1872-TRA	383.63	425.49	-	-
	KING-2448-TRA	332.80	369.53	-	-
	KING-2460-TRA	359.71	399.44	-	-
	KING-2472-TRA	424.21	471.20	-	-
	KING-3048-TRA	359.27	398.58	-	-
	KING-3060-TRA	404.99	449.84	-	-
KING-3072-TRA	472.92	525.46	-	-	
Half Round	KING-3618-HRD	317.84	353.30	-	-
	KING-4824-HRD	373.80	415.24	-	-
	KING-6030-HRD	453.69	504.52	-	-
	KING-7272-HRD	566.47	628.41	-	-
Quarter Round	KING-1818-QRD	318.27	353.72	-	-
	KING-2424-QRD	334.93	371.24	-	-
	KING-3030-QRD	372.95	414.39	-	-
	KING-3636-QRD	416.10	462.24	-	-
Crescent	KING-1872-CRE	542.13	602.78	-	-
	KING-1894-CRE	757.43	841.17	-	-
	KING-2472-CRE	542.13	602.78	-	-
	KING-2494-CRE	757.43	841.17	-	-
	KING-3072-CRE	542.13	602.78	-	-
	KING-3094-CRE	757.43	841.17	-	-

TRAINING & TASK TABLES

Kingston

GS-28F-0015W

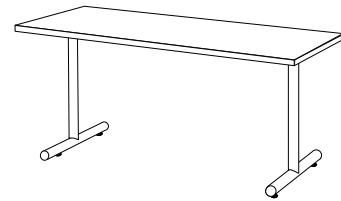

Kingston Options

MODEL NUMBER	DESCRIPTION	ADD-ON	
		TABLES UNDER 84" LONG	TABLES 84" & LONGER
-TL	T-Leg Option	-	-
-CL	C-Leg Option	-	-
-ATL	Arched Leg	60.66	-
-CA	Casters	32.47	48.70
-42	Bar Height	53.83	80.74
-36	Counter Height	53.83	80.74
-SC	Skate Casters	54.68	-
-FL	Folding Leg	211.89	317.84
-AH	Adjustable Height 26" to 36"	93.13	139.70
-AH42	Adjustable Height 33" to 42"	178.57	267.86
-CUSTHT1	Custom Height between 5" - 28.99"	58.10	87.15
-CUSTHT2	Custom Height between 29" - 42"	111.93	167.89

Accessories for Training & Task Tables

OPTION	DESCRIPTION	PRICE
Modesty Panels	Perforated steel, laminate, Acrylite modesty panel and removable laminate for folding option	Visit SpecialT.net
Privacy Screens	Acrylite Privacy Screens	
Grommets	Round or Rectangle	
Power & Data Management	Burele, EZ Power, Nacre, MhoB, Dean, Node, Ashley Duo Air, Villa, Cove, Interact G2	
Wire Management	J-Shape wire manager and table leg wire channel	
Table Connector	Quick Align	

*An Oversize Fee has been implemented by freight carriers for all LTL shipments for pallets 8' and over.
96"-108" - additional \$250.00 | 109" -168" - additional \$350.00 | Per custom pallet

TRAINING & TASK TABLES

Quatro

GS-28F-0015W

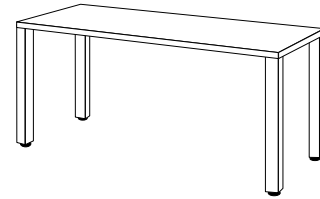

		CONFIGURE & PRICE			
	MODEL NUMBER	TFL	HPL	1-DAY	5-DAY
Rectangle	QUAT-1824	306.31	340.05	-	-
	QUAT-1830	316.13	350.73	-	-
	QUAT-1836	327.23	363.98	-	-
	QUAT-1842	341.34	378.50	-	-
	QUAT-1848	358.43	398.16	-	-
	QUAT-1854	367.82	408.40	-	-
	QUAT-1860	375.94	417.38	-	-
	QUAT-1866	410.12	455.40	-	-
	QUAT-1872	429.76	477.61	-	-
	QUAT-1878	501.96	557.50	-	-
	QUAT-1884	553.23	614.32	-	-
	QUAT-1896	587.41	652.77	-	-
	QUAT-2430	333.64	370.81	-	-
	QUAT-2436	345.61	384.06	-	-
	QUAT-2442	360.56	401.15	-	-
	QUAT-2448	375.94	417.38	-	-
	QUAT-2454	389.61	433.19	-	-
	QUAT-2460	403.71	448.14	-	-
	QUAT-2466	449.84	499.41	-	-
	QUAT-2472	472.92	525.04	-	-
	QUAT-2478	589.96	655.34	-	-
	QUAT-2484	575.45	639.09	-	-
	QUAT-2496	623.29	692.93	-	-
	QUAT-3042	384.06	426.78	-	-
	QUAT-3048	403.71	448.14	-	-
	QUAT-3054	426.35	473.34	-	-
	QUAT-3060	448.99	498.97	-	-
	QUAT-3066	490.43	544.69	-	-
QUAT-3072	522.47	580.57	-	-	
QUAT-3078	605.77	673.70	-	-	
QUAT-3084	629.27	699.76	-	-	
QUAT-3096	707.45	786.48	-	-	

TRAINING & TASK TABLES

Quatro

GS-28F-0015W

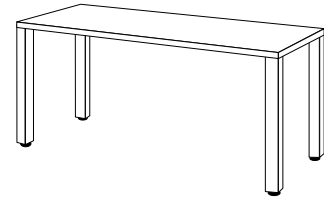

		CONFIGURE & PRICE			
	MODEL NUMBER	TFL	HPL	1-DAY	5-DAY
Rectangle	QUAT-3642	427.63	474.62	-	-
	QUAT-3648	448.99	498.97	-	-
	QUAT-3654	445.15	493.42	-	-
	QUAT-3660	503.68	559.21	-	-
	QUAT-3666	565.62	627.99	-	-
	QUAT-3672	582.71	648.07	-	-
	QUAT-3678	658.75	731.38	-	-
	QUAT-3684	712.15	791.61	-	-
	QUAT-3696	751.88	835.61	-	-

Quatro Options

MODEL NUMBER	DESCRIPTION	ADD-ON
-CA	Castors	32.47
-42	Bar Height	107.66
-CUSTHT1	Custom Height between 5" - 28.99"	116.20
-CUSTHT2	Custom Height between 29" - 42"	223.85

Accessories for Training & Task Tables

OPTION	DESCRIPTION	PRICE
Modesty Panels	Perforated steel, laminate, Acrylite modesty panel and removable laminate for folding option	Visit SpecialT.net
Privacy Screens	Acrylite Privacy Screens	
Grommets	Round or Rectangle	
Power & Data Management	Burele, EZ Power, Nacre, MhoB, Dean, Node, Ashley Duo Air, Villa, Cove, Interact G2	
Wire Management	J-Shape wire manager and table leg wire channel	
Table Connector	Quick Align	

*An Oversize Fee has been implemented by freight carriers for all LTL shipments for pallets 8' and over.
96"-108" - additional \$250.00 | 109" -168" - additional \$350.00 | Per custom pallet

TRAINING & TASK TABLES

Robot

GS-28F-0015W

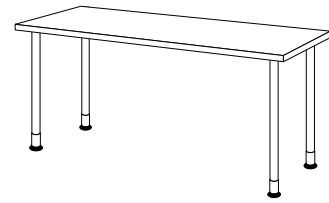

		CONFIGURE & PRICE				
	MODEL NUMBER	TFL	HPL	1-DAY	5-DAY	
		Rectangle	ROBT-1824	306.31	340.05	-
ROBT-1830	316.13		350.73	-	-	
ROBT-1836	326.39		361.84	-	-	
ROBT-1842	341.34		378.50	-	-	
ROBT-1848	358.43		398.16	-	-	
ROBT-1854	367.82		408.40	-	-	
ROBT-1860	375.94		417.38	-	-	
ROBT-1866	410.12		455.40	-	-	
ROBT-1872	429.76		477.61	-	-	
ROBT-1878	478.89		532.73	-	-	
ROBT-1884	529.73		588.69	-	-	
ROBT-1896	565.62		627.99	-	-	
ROBT-2430	333.64		370.81	-	-	
ROBT-2436	345.18		383.63	-	-	
ROBT-2442	360.56		401.15	-	-	
ROBT-2448	375.94		417.38	-	-	
ROBT-2454	389.61		433.19	-	-	
ROBT-2460	403.71		448.14	-	-	
ROBT-2466	449.84		499.41	-	-	
ROBT-2472	472.92		525.04	-	-	
ROBT-2478	513.07		570.32	-	-	
ROBT-2484	553.23		614.32	-	-	
ROBT-2496	600.22		667.29	-	-	
ROBT-3042	384.06		426.78	-	-	
ROBT-3048	403.71		448.14	-	-	
ROBT-3054	426.35		473.34	-	-	
ROBT-3060	448.99		498.97	-	-	
ROBT-3066	490.43		544.69	-	-	
ROBT-3072	522.47		580.57	-	-	
ROBT-3078	583.56		648.49	-	-	
ROBT-3084	645.08	716.85	-	-		
ROBT-3096	684.81	760.85	-	-		

TRAINING & TASK TABLES

Robot

GS-28F-0015W

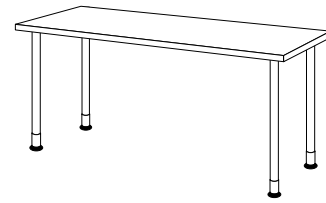

		CONFIGURE & PRICE			
	MODEL NUMBER	TFL	HPL	1-DAY	5-DAY
Rectangle	ROBT-3642	427.63	474.62	-	-
	ROBT-3648	445.57	495.13	-	-
	ROBT-3654	448.99	498.97	-	-
	ROBT-3660	503.68	559.21	-	-
	ROBT-3666	565.62	627.99	-	-
	ROBT-3672	582.71	648.07	-	-
	ROBT-3678	636.11	706.60	-	-
	ROBT-3684	689.51	765.55	-	-
	ROBT-3696	729.66	809.97	-	-
Trapezoid	ROBT-1848-TRA	369.95	410.97	-	-
	ROBT-1860-TRA	388.76	431.05	-	-
	ROBT-1872-TRA	444.72	493.00	-	-
	ROBT-2448-TRA	388.76	431.05	-	-
	ROBT-2460-TRA	419.08	464.37	-	-
	ROBT-2472-TRA	489.57	543.41	-	-
	ROBT-3048-TRA	419.08	464.37	-	-
	ROBT-3060-TRA	468.64	520.33	-	-
	ROBT-3072-TRA	543.83	604.07	-	-
1/2 Round	ROBT-1836-HRD	373.80	415.67	-	-
	ROBT-2448-HRD	434.89	483.16	-	-
	ROBT-3060-HRD	523.75	581.42	-	-
	ROBT-3672-HRD	644.65	716.42	-	-
1/4 Round	ROBT-1818-QRD	302.04	334.50	-	-
	ROBT-2424-QRD	318.69	354.16	-	-
	ROBT-3030-QRD	359.71	399.44	-	-
	ROBT-3636-QRD	409.69	453.69	-	-
Crescent	ROBT-1872-CRE	604.92	671.99	-	-
	ROBT-1894-CRE	839.88	933.44	-	-
	ROBT-2472-CRE	604.92	671.99	-	-
	ROBT-2494-CRE	839.88	933.44	-	-
	ROBT-3072-CRE	604.92	671.99	-	-
	ROBT-3094-CRE	839.88	933.44	-	-

TRAINING & TASK TABLES

Robot

GS-28F-0015W

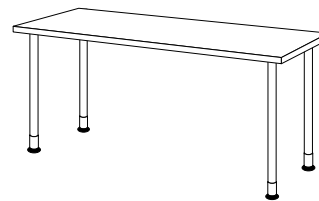

Robot Options

MODEL NUMBER	DESCRIPTION	ADD-ON
-SC	Skate Casters	-
-AH	Adjustable Height	54.68
-CUSTHT1	Custom Height between 5" - 28.99"	116.20

Accessories for Training & Task Tables

OPTION	DESCRIPTION	PRICE
Modesty Panels	Perforated steel, laminate, Acrylite modesty panel and removable laminate for folding option	Visit SpecialT.net
Privacy Screens	Acrylite Privacy Screens	
Grommets	Round or Rectangle	
Power & Data Management	Burele, EZ Power, Nacre, MhoB, Dean, Node, Ashley Duo Air, Villa, Cove, Interact G2	
Wire Management	J-Shape wire manager and table leg wire channel	
Table Connector	Quick Align	

*An Oversize Fee has been implemented by freight carriers for all LTL shipments for pallets 8' and over.
96"-108" - additional \$250.00 | 109" -168" - additional \$350.00 | Per custom pallet

TRAINING & TASK TABLES

Sienna TL

GS-28F-0015W

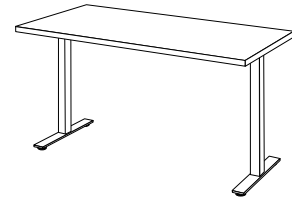

		CONFIGURE & PRICE			
Rectangle	MODEL NUMBER	TFL	HPL	1-DAY	5-DAY
	SIEN-1TL-2436	408.40	453.26	-	-
	SIEN-1TL-2442	416.10	462.24	-	-
	SIEN-1TL-2448	430.62	478.47	-	-
	SIEN-1TL-2454	473.77	526.32	-	-
	SIEN-1TL-2460	489.57	543.41	-	-
	SIEN-1TL-2466	509.65	566.05	-	-
	SIEN-1TL-2472	527.60	586.13	-	-
	SIEN-1TL-2484	608.34	674.98	-	-
	SIEN-1TL-3036	420.80	467.37	-	-
	SIEN-1TL-3042	439.60	487.44	-	-
	SIEN-1TL-3048	458.82	510.09	-	-
	SIEN-1TL-3054	511.79	568.60	-	-
	SIEN-1TL-3060	533.58	592.96	-	-
	SIEN-1TL-3066	549.38	610.90	-	-
	SIEN-1TL-3072	577.15	641.66	-	-
	SIEN-1TL-3084	698.48	776.65	-	-
	SIEN-1TL-3648	504.10	560.06	-	-
	SIEN-1TL-3654	554.51	616.89	-	-
	SIEN-1TL-3660	588.69	654.48	-	-
SIEN-1TL-3666	623.29	692.93	-	-	
SIEN-1TL-3672	637.39	708.30	-	-	
SIEN-1TL-3684	699.76	777.51	-	-	

Sienna TL Options

MODEL NUMBER	DESCRIPTION	ADD-ON
-TL	T-Leg Option	-
-CL	C-Leg Option	-
-SC	Skate Casters	54.68
-42	Bar Height	53.83
-CUSTHT1	Custom Height between 5" - 28.99"	58.10
-CUSTHT2	Custom Height between 29" - 42"	111.93

Accessories for Training & Task Tables

OPTION	DESCRIPTION	PRICE
Modesty Panels	Perforated steel, laminate, Acrylite modesty panel and removable laminate for folding option	Visit SpecialT.net
Privacy Screens	Acrylite Privacy Screens	
Grommets	Round or Rectangle	
Power & Data Management	Burele, EZ Power, Nacre, MhoB, Dean, Node, Ashley Duo Air, Villa, Cove, Interact G2	
Wire Management	J-Shape wire manager and table leg wire channel	
Table Connector	Quick Align	

TRAINING & TASK TABLES

Structure 2T

GS-28F-0015W

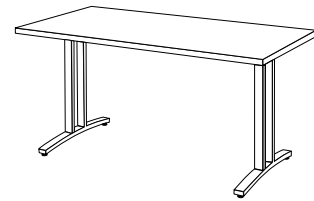

CONFIGURE & PRICE

	MODEL NUMBER	CONFIGURE & PRICE		1-DAY	5-DAY
		TFL	HPL		
Rectangle	STRU-2T-1848	409.69	454.97	-	-
	STRU-2T-1860	454.97	504.96	-	-
	STRU-2T-1872	489.57	543.41	-	-
	STRU-2T-2436	411.40	457.53	-	-
	STRU-2T-2442	427.20	474.20	-	-
	STRU-2T-2448	443.87	493.00	-	-
	STRU-2T-2454	468.21	520.33	-	-
	STRU-2T-2460	504.52	560.92	-	-
	STRU-2T-2466	535.72	595.53	-	-
	STRU-2T-2472	574.59	637.81	-	-
	STRU-2T-3036	421.65	468.21	-	-
	STRU-2T-3042	445.57	495.13	-	-
	STRU-2T-3048	466.51	518.20	-	-
	STRU-2T-3054	491.71	546.40	-	-
	STRU-2T-3060	523.32	581.00	-	-
	STRU-2T-3066	560.49	622.44	-	-
STRU-2T-3072	598.09	664.30	-	-	

Structure-2T Options

MODEL NUMBER	DESCRIPTION	ADD-ON
-CA	Casters	30.76

Accessories for Training & Task Tables

OPTION	DESCRIPTION	PRICE
Modesty Panels	Perforated steel, laminate, Acrylite modesty panel and removable laminate for folding option	Visit SpecialT.net
Privacy Screens	Acrylite Privacy Screens	
Grommets	Round or Rectangle	
Power & Data Management	Burele, EZ Power, Nacre, MhoB, Dean, Node, Ashley Duo Air, Villa, Cove, Interact G2	
Wire Management	J-Shape wire manager and table leg wire channel	
Table Connector	Quick Align	

TRAINING & TASK TABLES

Structure 2C

GS-28F-0015W

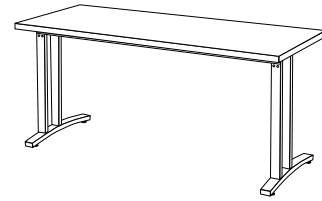

		CONFIGURE & PRICE			
	MODEL NUMBER	TFL	HPL	1-DAY	5-DAY
Rectangle	STRU-2C-2436	409.69	454.97	-	-
	STRU-2C-2442	427.20	474.20	-	-
	STRU-2C-2448	443.87	493.00	-	-
	STRU-2C-2454	468.21	520.33	-	-
	STRU-2C-2460	504.52	560.92	-	-
	STRU-2C-2466	535.72	595.53	-	-
	STRU-2C-2472	574.59	637.81	-	-
	STRU-2C-3036	421.65	468.21	-	-
	STRU-2C-3042	445.57	495.13	-	-
	STRU-2C-3048	466.51	518.20	-	-
	STRU-2C-3054	491.71	546.40	-	-
	STRU-2C-3060	523.32	581.00	-	-
	STRU-2C-3066	560.49	622.44	-	-
	STRU-2C-3072	598.09	664.30	-	-

Structure 2C Options

MODEL NUMBER	DESCRIPTION	ADD-ON
-CA	Casters	30.76

Accessories for Training & Task Tables

OPTION	DESCRIPTION	PRICE
Modesty Panels	Perforated steel, laminate, Acrylite modesty panel and removable laminate for folding option	Visit SpecialT.net
Privacy Screens	Acrylite Privacy Screens	
Grommets	Round or Rectangle	
Power & Data Management	Burele, EZ Power, Nacre, MhoB, Dean, Node, Ashley Duo Air, Villa, Cove, Interact G2	
Wire Management	J-Shape wire manager and table leg wire channel	
Table Connector	Quick Align	

TRAINING & TASK TABLES

Structure H

GS-28F-0015W

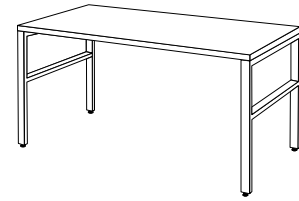

		CONFIGURE & PRICE			
	MODEL NUMBER	TFL	HPL	1-DAY	5-DAY
Rectangle	STRU-H-2436	413.53	458.82	-	-
	STRU-H-2442	421.22	467.79	-	-
	STRU-H-2448	436.17	485.30	-	-
	STRU-H-2454	451.98	501.96	-	-
	STRU-H-2460	497.69	553.23	-	-
	STRU-H-2466	518.20	575.45	-	-
	STRU-H-2472	537.00	596.81	-	-
	STRU-H-3036	448.14	498.12	-	-
	STRU-H-3042	468.21	520.33	-	-
	STRU-H-3048	490.01	543.83	-	-
	STRU-H-3054	515.20	572.03	-	-
	STRU-H-3060	566.05	628.41	-	-
	STRU-H-3066	584.41	649.35	-	-
	STRU-H-3072	611.76	679.68	-	-

Accessories for Training & Task Tables

OPTION	DESCRIPTION	PRICE
Modesty Panels	Perforated steel, laminate, Acrylite modesty panel and removable laminate for folding option	Visit SpecialT.net
Privacy Screens	Acrylite Privacy Screens	
Grommets	Round or Rectangle	
Power & Data Management	Burele, EZ Power, Nacre, MhoB, Dean, Node, Ashley Duo Air, Villa, Cove, Interact G2	
Wire Management	J-Shape wire manager and table leg wire channel	
Table Connector	Quick Align	

TRAINING & TASK TABLES

Structure Square

GS-28F-0015W

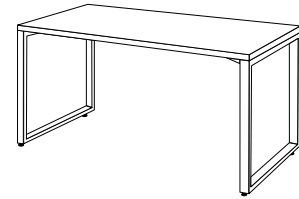

		CONFIGURE & PRICE			
	MODEL NUMBER	TFL	HPL	1-DAY	5-DAY
Rectangle	STRU-SQ-2436	435.75	484.02	-	-
	STRU-SQ-2442	445.15	493.42	-	-
	STRU-SQ-2448	459.24	510.51	-	-
	STRU-SQ-2454	476.33	528.88	-	-
	STRU-SQ-2460	520.77	578.01	-	-
	STRU-SQ-2466	541.69	601.50	-	-
	STRU-SQ-2472	560.06	622.01	-	-
	STRU-SQ-3036	471.20	523.75	-	-
	STRU-SQ-3042	491.71	546.40	-	-
	STRU-SQ-3048	513.07	570.32	-	-
	STRU-SQ-3054	537.85	598.09	-	-
	STRU-SQ-3060	589.54	654.90	-	-
	STRU-SQ-3066	606.21	674.13	-	-
	STRU-SQ-3072	635.25	706.17	-	-

Accessories for Training & Task Tables

OPTION	DESCRIPTION	PRICE
Modesty Panels	Perforated steel, laminate, Acrylite modesty panel and removable laminate for folding option	Visit SpecialT.net
Privacy Screens	Acrylite Privacy Screens	
Grommets	Round or Rectangle	
Power & Data Management	Burele, EZ Power, Nacre, MhoB, Dean, Node, Ashley Duo Air, Villa, Cove, Interact G2	
Wire Management	J-Shape wire manager and table leg wire channel	
Table Connector	Quick Align	

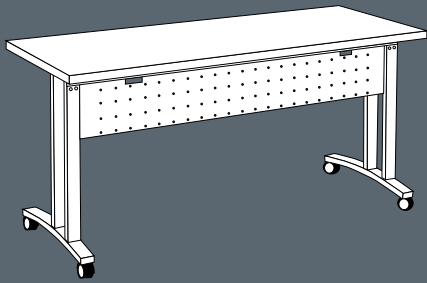

FLIP & NEST TABLES

GS-28F-0015W

FLIP & NEST TABLES

Convertible

GS-28F-0015W



		CONFIGURE & PRICE			
	MODEL NUMBER	TFL	HPL	1-DAY	5-DAY
Rectangle	CONV-1848	566.90	629.70	-	-
	CONV-1854	580.57	645.08	-	-
	CONV-1860	597.66	663.88	-	-
	CONV-1866	610.05	677.97	-	-
	CONV-1872	629.70	700.19	-	-
	CONV-2448	597.66	663.88	-	-
	CONV-2454	616.45	684.38	-	-
	CONV-2460	638.67	709.16	-	-
	CONV-2466	663.88	736.93	-	-
	CONV-2472	688.22	764.27	-	-
	CONV-3048	638.67	709.16	-	-
	CONV-3054	665.58	739.92	-	-
	CONV-3060	698.06	775.38	-	-
	CONV-3066	725.39	805.70	-	-
	CONV-3072	752.74	836.04	-	-

Accessories for Flip & Nest Tables

OPTION	DESCRIPTION	PRICE
Modesty Panels	Perforated steel, laminate, Acrylite modesty panel and removable laminate for folding option	Visit SpecialT.net
Privacy Screens	Acrylite Privacy Screens	
Grommets	Round or Rectangle	
Power & Data Management	Burele, EZ Power, Nacre, MhoB, Dean, Node, Ashley Duo Air, Villa, Cove, Interact G2	
Wire Management	J-Shape wire manager and table leg wire channel	
Table Connector	Quick Align	

FLIP & NEST TABLES
Kingston Flip

GS-28F-0015W

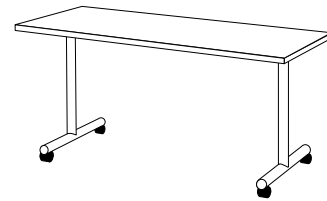

		CONFIGURE & PRICE			
	MODEL NUMBER	TFL	HPL	1-DAY	5-DAY
Rectangle	KINGFLIP-1848	504.52	560.49	-	-
	KINGFLIP-1854	516.06	574.17	-	-
	KINGFLIP-1860	528.88	587.41	-	-
	KINGFLIP-1866	539.99	599.80	-	-
	KINGFLIP-1872	558.78	620.30	-	-
	KINGFLIP-1884	598.09	664.73	-	-
	KINGFLIP-2448	520.33	577.58	-	-
	KINGFLIP-2454	539.56	598.94	-	-
	KINGFLIP-2460	556.22	618.17	-	-
	KINGFLIP-2466	578.01	642.94	-	-
	KINGFLIP-2472	600.22	667.29	-	-
	KINGFLIP-2484	647.64	719.84	-	-
	KINGFLIP-3048	546.82	607.91	-	-
	KINGFLIP-3054	574.59	637.81	-	-
	KINGFLIP-3060	600.22	667.29	-	-
	KINGFLIP-3066	624.57	694.63	-	-
KINGFLIP-3072	648.49	720.26	-	-	
KINGFLIP-3084	701.89	779.65	-	-	

Accessories for Flip & Nest Tables

OPTION	DESCRIPTION	PRICE
Modesty Panels	Perforated steel, laminate, Acrylite modesty panel and removable laminate for folding option	Visit SpecialT.net
Privacy Screens	Acrylite Privacy Screens	
Grommets	Round or Rectangle	
Power & Data Management	Burele, EZ Power, Nacre, MhoB, Dean, Node, Ashley Duo Air, Villa, Cove, Interact G2	
Wire Management	J-Shape wire manager and table leg wire channel	
Table Connector	Quick Align	

FLIP & NEST TABLES
Kingston Flip C

GS-28F-0015W

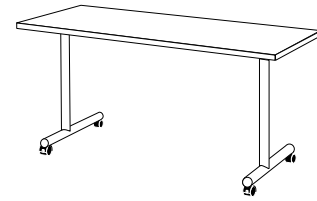

		CONFIGURE & PRICE			
	MODEL NUMBER	TFL	HPL	1-DAY	5-DAY
Rectangle	KINGFLIP-C-1848	504.52	560.49	-	-
	KINGFLIP-C-1860	528.88	587.41	-	-
	KINGFLIP-C-1872	558.78	620.30	-	-
	KINGFLIP-C-2448	520.33	577.58	-	-
	KINGFLIP-C-2460	556.22	618.17	-	-
	KINGFLIP-C-2472	600.22	667.29	-	-
	KINGFLIP-C-3048	546.82	607.91	-	-
	KINGFLIP-C-3060	600.22	667.29	-	-
	KINGFLIP-C-3072	648.49	720.26	-	-

Accessories for Flip & Nest Tables

OPTION	DESCRIPTION	PRICE
Modesty Panels	Perforated steel, laminate, Acrylite modesty panel and removable laminate for folding option	Visit SpecialT.net
Privacy Screens	Acrylite Privacy Screens	
Grommets	Round or Rectangle	
Power & Data Management	Burele, EZ Power, Nacre, MhoB, Dean, Node, Ashley Duo Air, Villa, Cove, Interact G2	
Wire Management	J-Shape wire manager and table leg wire channel	
Table Connector	Quick Align	

FLIP & NEST TABLES

Kingston Flip Arched

GS-28F-0015W

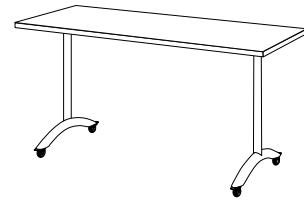

		CONFIGURE & PRICE			
	MODEL NUMBER	TFL	HPL	1-DAY	5-DAY
Rectangle	KINGFLIP-ATL-2448	581.00	638.25	-	-
	KINGFLIP-ATL-2460	616.89	678.83	-	-
	KINGFLIP-ATL-2472	660.89	727.96	-	-
	KINGFLIP-ATL-3048	607.49	668.57	-	-
	KINGFLIP-ATL-3060	660.89	727.96	-	-
	KINGFLIP-ATL-3072	709.16	780.93	-	-

Accessories for Flip & Nest Tables

OPTION	DESCRIPTION	PRICE
Modesty Panels	Perforated steel, laminate, Acrylite modesty panel and removable laminate for folding option	Visit SpecialT.net
Privacy Screens	Acrylite Privacy Screens	
Grommets	Round or Rectangle	
Power & Data Management	Burele, EZ Power, Nacre, MhoB, Dean, Node, Ashley Duo Air, Villa, Cove, Interact G2	
Wire Management	J-Shape wire manager and table leg wire channel	
Table Connector	Quick Align	

FLIP & NEST TABLES

Structure Flip Top T

GS-28F-0015W

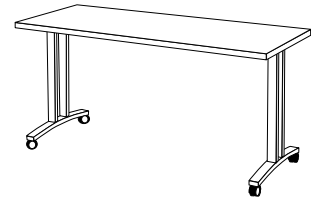

CONFIGURE & PRICE

	MODEL NUMBER	TFL	HPL	1-DAY	5-DAY
Rectangle	STRU-FT-T-2448	636.11	706.60	-	-
	STRU-FT-T-2460	667.29	741.20	-	-
	STRU-FT-T-2472	698.06	775.38	-	-
	STRU-FT-T-3048	674.13	748.89	-	-
	STRU-FT-T-3060	732.23	814.25	-	-
	STRU-FT-T-3072	775.38	861.67	-	-
	STRU-FT-T-3648	714.29	793.32	-	-
	STRU-FT-T-3660	779.22	865.94	-	-
	STRU-FT-T-3672	828.78	921.05	-	-
Round	STRU-FT-T-60	-	1,331.16	-	-

Accessories for Flip & Nest Tables

OPTION	DESCRIPTION	PRICE
Modesty Panels	Perforated steel, laminate, Acrylite modesty panel and removable laminate for folding option	Visit SpecialT.net
Privacy Screens	Acrylite Privacy Screens	
Grommets	Round or Rectangle	
Power & Data Management	Burele, EZ Power, Nacre, MhoB, Dean, Node, Ashley Duo Air, Villa, Cove, Interact G2	
Wire Management	J-Shape wire manager and table leg wire channel	
Table Connector	Quick Align	

FLIP & NEST TABLES

Structure Flip Top C

GS-28F-0015W

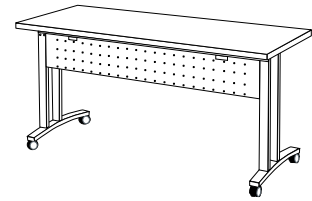

CONFIGURE & PRICE

	MODEL NUMBER	TFL	HPL	1-DAY	5-DAY
Rectangle	STRU-FT-C-2448	701.47	779.22	-	-
	STRU-FT-C-2460	747.18	830.49	-	-
	STRU-FT-C-2472	798.87	887.73	-	-
	STRU-FT-C-3048	729.66	810.41	-	-
	STRU-FT-C-3060	812.97	903.11	-	-
	STRU-FT-C-3072	897.13	997.10	-	-

Accessories for Flip & Nest Tables

OPTION	DESCRIPTION	PRICE
Modesty Panels	Perforated steel, laminate, Acrylite modesty panel and removable laminate for folding option	Visit SpecialT.net
Privacy Screens	Acrylite Privacy Screens	
Grommets	Round or Rectangle	
Power & Data Management	Burele, EZ Power, Nacre, MhoB, Dean, Node, Ashley Duo Air, Villa, Cove, Interact G2	
Wire Management	J-Shape wire manager and table leg wire channel	
Table Connector	Quick Align	

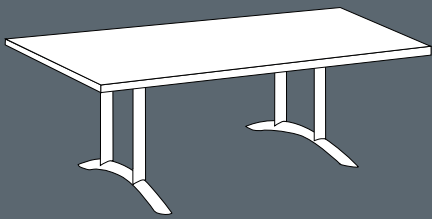

CONFERENCE TABLES

GS-28F-0015W

CONFERENCE TABLES

AIM XL

GS-28F-0015W

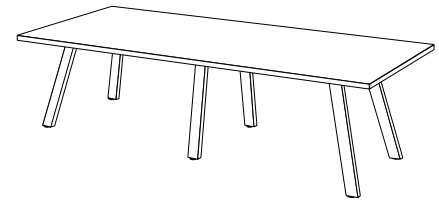

CONFIGURE & PRICE

	MODEL NUMBER	TFL	HPL	1-DAY	5-DAY
Rectangle	AIM-XL-3672	-	889.44	-	-
	AIM-XL-3678	-	913.36	-	-
	AIM-XL-3684	-	945.40	-	-
	AIM-XL-3696	-	1,084.68	-	-
	AIM-XL-36108	-	1,233.34	-	-
	AIM-XL-36120	-	1,242.31	-	-
	AIM-XL-36144	-	1,346.55	-	-
	AIM-XL-36168	-	1,630.64	-	-
	AIM-XL-36192	-	1,706.68	-	-
	AIM-XL-36216	-	1,919.00	-	-
	AIM-XL-3678	-	1,032.55	-	-
	AIM-XL-3684	-	1,098.34	-	-
	AIM-XL-3696	-	1,176.95	-	-
	AIM-XL-36108	-	1,373.04	-	-
	AIM-XL-36120	-	1,438.82	-	-
	AIM-XL-36144	-	1,569.12	-	-
	AIM-XL-36168	-	1,864.32	-	-
	AIM-XL-36192	-	1,952.32	-	-
	AIM-XL-3216	-	2,224.88	-	-
	AIM-XL-4884	-	1,124.40	-	-
	AIM-XL-4896	-	1,190.19	-	-
	AIM-XL-48108	-	1,418.74	-	-
	AIM-XL-48120	-	1,503.34	-	-
	AIM-XL-48144	-	1,699.85	-	-
	AIM-XL-48168	-	1,868.59	-	-
	AIM-XL-48192	-	1,957.02	-	-
	AIM-XL-48216	-	2,229.15	-	-
	AIM-XL-6096	-	1,242.31	-	-
	AIM-XL-60108	-	1,549.47	-	-
	AIM-XL-60120	-	1,601.59	-	-
	AIM-XL-60144	-	1,830.99	-	-
	AIM-XL-60168	-	2,106.97	-	-
AIM-XL-60192	-	2,203.52	-	-	
AIM-XL-60216	-	2,535.03	-	-	

CONFERENCE TABLES

AIM XL

GS-28F-0015W

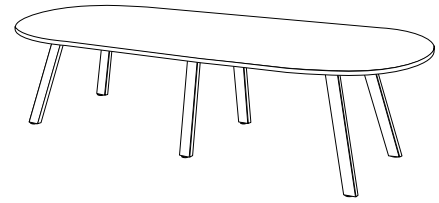

CONFIGURE & PRICE

	MODEL NUMBER	CONFIGURE & PRICE			
		TFL	HPL	1-DAY	5-DAY
Racetrack	AIM-XL-3672-RC	-	953.94	-	-
	AIM-XL-3678-RC	-	979.15	-	-
	AIM-XL-3684-RC	-	1,011.19	-	-
	AIM-XL-3696-RC	-	1,150.46	-	-
	AIM-XL-36108-RC	-	1,298.70	-	-
	AIM-XL-36120-RC	-	1,308.10	-	-
	AIM-XL-36144-RC	-	1,412.33	-	-
	AIM-XL-36168-RC	-	1,860.05	-	-
	AIM-XL-36192-RC	-	1,923.27	-	-
	AIM-XL-36216-RC	-	2,106.12	-	-
	AIM-XL-3678-RC	-	1,098.34	-	-
	AIM-XL-3684-RC	-	1,163.71	-	-
	AIM-XL-3696-RC	-	1,202.58	-	-
	AIM-XL-36108-RC	-	1,438.82	-	-
	AIM-XL-36120-RC	-	1,503.34	-	-
	AIM-XL-36144-RC	-	1,634.48	-	-
	AIM-XL-36168-RC	-	2,077.07	-	-
	AIM-XL-36192-RC	-	2,153.11	-	-
	AIM-XL-3216-RC	-	2,399.17	-	-
	AIM-XL-4884-RC	-	1,176.95	-	-
	AIM-XL-4896-RC	-	1,209.84	-	-
	AIM-XL-48108-RC	-	1,484.11	-	-
	AIM-XL-48120-RC	-	1,569.12	-	-
	AIM-XL-48144-RC	-	1,765.21	-	-
	AIM-XL-48168-RC	-	2,081.34	-	-
	AIM-XL-48192-RC	-	2,153.11	-	-
	AIM-XL-48216-RC	-	2,407.72	-	-
	AIM-XL-6096-RC	-	1,254.70	-	-
	AIM-XL-60108-RC	-	1,614.83	-	-
	AIM-XL-60120-RC	-	1,666.95	-	-
	AIM-XL-60144-RC	-	1,895.93	-	-
	AIM-XL-60168-RC	-	2,391.49	-	-
AIM-XL-60192-RC	-	2,475.22	-	-	
AIM-XL-60216-RC	-	2,777.25	-	-	

CONFERENCE TABLES

AIM XL

GS-28F-0015W

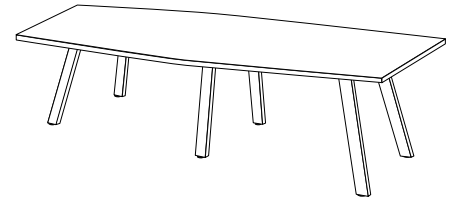

CONFIGURE & PRICE

	MODEL NUMBER	TFL	HPL	1-DAY	5-DAY
Boat Shape	AIM-XL-3672-BT	-	953.94	-	-
	AIM-XL-3678-BT	-	979.15	-	-
	AIM-XL-3684-BT	-	1,011.19	-	-
	AIM-XL-3696-BT	-	1,150.46	-	-
	AIM-XL-36108-BT	-	1,298.70	-	-
	AIM-XL-36120-BT	-	1,308.10	-	-
	AIM-XL-36144-BT	-	1,412.33	-	-
	AIM-XL-36168-BT	-	1,860.05	-	-
	AIM-XL-36192-BT	-	1,923.27	-	-
	AIM-XL-36216-BT	-	2,106.12	-	-
	AIM-XL-3678-BT	-	1,098.34	-	-
	AIM-XL-3684-BT	-	1,163.71	-	-
	AIM-XL-3696-BT	-	1,202.58	-	-
	AIM-XL-36108-BT	-	1,438.82	-	-
	AIM-XL-36120-BT	-	1,503.34	-	-
	AIM-XL-36144-BT	-	1,634.48	-	-
	AIM-XL-36168-BT	-	2,077.07	-	-
	AIM-XL-36192-BT	-	2,153.11	-	-
	AIM-XL-3216-BT	-	2,399.17	-	-
	AIM-XL-4884-BT	-	1,176.95	-	-
	AIM-XL-4896-BT	-	1,209.84	-	-
	AIM-XL-48108-BT	-	1,484.11	-	-
	AIM-XL-48120-BT	-	1,569.12	-	-
	AIM-XL-48144-BT	-	1,765.21	-	-
	AIM-XL-48168-BT	-	2,081.34	-	-
	AIM-XL-48192-BT	-	2,153.11	-	-
	AIM-XL-48216-BT	-	2,407.72	-	-
	AIM-XL-6096-BT	-	1,254.70	-	-
	AIM-XL-60108-BT	-	1,614.83	-	-
	AIM-XL-60120-BT	-	1,666.95	-	-
	AIM-XL-60144-BT	-	1,895.93	-	-
	AIM-XL-60168-BT	-	2,391.49	-	-
AIM-XL-60192-BT	-	2,475.22	-	-	
AIM-XL-60216-BT	-	2,777.25	-	-	

CONFERENCE TABLES

AIM XL

GS-28F-0015W

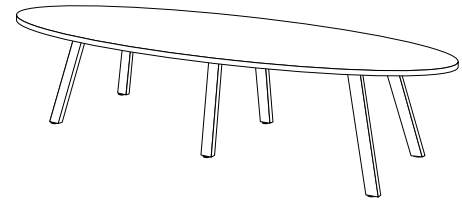

CONFIGURE & PRICE

	MODEL NUMBER	CONFIGURE & PRICE			
		TFL	HPL	1-DAY	5-DAY
Oval	AIM-XL-3672-OV	-	953.94	-	-
	AIM-XL-3678-OV	-	979.15	-	-
	AIM-XL-3684-OV	-	1,011.19	-	-
	AIM-XL-3696-OV	-	1,150.46	-	-
	AIM-XL-36108-OV	-	1,298.70	-	-
	AIM-XL-36120-OV	-	1,308.10	-	-
	AIM-XL-36144-OV	-	1,412.33	-	-
	AIM-XL-36168-OV	-	1,860.05	-	-
	AIM-XL-36192-OV	-	1,923.27	-	-
	AIM-XL-36216-OV	-	2,106.12	-	-
	AIM-XL-3678-OV	-	1,098.34	-	-
	AIM-XL-3684-OV	-	1,163.71	-	-
	AIM-XL-3696-OV	-	1,202.58	-	-
	AIM-XL-36108-OV	-	1,438.82	-	-
	AIM-XL-36120-OV	-	1,503.34	-	-
	AIM-XL-36144-OV	-	1,634.48	-	-
	AIM-XL-36168-OV	-	2,077.07	-	-
	AIM-XL-36192-OV	-	2,153.11	-	-
	AIM-XL-3216-OV	-	2,399.17	-	-
	AIM-XL-4884-OV	-	1,176.95	-	-
	AIM-XL-4896-OV	-	1,209.84	-	-
	AIM-XL-48108-OV	-	1,484.11	-	-
	AIM-XL-48120-OV	-	1,569.12	-	-
	AIM-XL-48144-OV	-	1,765.21	-	-
	AIM-XL-48168-OV	-	2,081.34	-	-
	AIM-XL-48192-OV	-	2,153.11	-	-
	AIM-XL-48216-OV	-	2,407.72	-	-
	AIM-XL-6096-OV	-	1,254.70	-	-
	AIM-XL-60108-OV	-	1,614.83	-	-
	AIM-XL-60120-OV	-	1,666.95	-	-
	AIM-XL-60144-OV	-	1,895.93	-	-
	AIM-XL-60168-OV	-	2,391.49	-	-
AIM-XL-60192-OV	-	2,475.22	-	-	
AIM-XL-60216-OV	-	2,777.25	-	-	

CONFERENCE TABLES

AIM XL

GS-28F-0015W

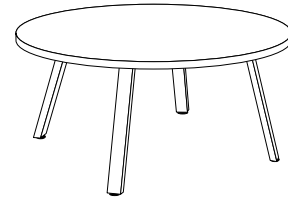

CONFIGURE & PRICE

	MODEL NUMBER	TFL	HPL	1-DAY	5-DAY
Round	AIM-XL-42R	741.62	823.65	-	-
	AIM-XL-48R	765.12	849.71	-	-
	AIM-XL-54R	871.07	967.62	-	-
	AIM-XL-60R	882.18	980.43	-	-
	AIM-XL-66R	-	1,399.09	-	-
	AIM-XL-72R	-	1,425.15	-	-
Square	AIM-XL-4242	706.17	784.34	-	-
	AIM-XL-4848	735.65	817.24	-	-
	AIM-XL-5454	871.07	967.62	-	-
	AIM-XL-6060	929.59	1,032.55	-	-
	AIM-XL-6666	-	1,176.95	-	-
	AIM-XL-7272	-	1,242.31	-	-

AIM XL Options

MODEL NUMBER	DESCRIPTION	ADD-ON		
		TABLES UP TO 96" LONG	TABLES 108" TO 144" LONG	TABLES 168" TO 216" LONG
-42	Bar Height 42"	22.22	33.32	44.43
-CC	Cloud Caster	22.22	33.32	44.43
-WM-INT	Integrated Wire Management	28.19 per Leg		
	2 Piece Table Top Standard for sizes over 108"	-	-	-
	1 Piece Table Top for sizes up to 168"	227.27	227.27	227.27

Accessories for Conference Tables

OPTION	DESCRIPTION	PRICE
Grommets	Round or Rectangle	Visit SpecialT.net
Power & Data Management	Burele, EZ Power, Nacre, MhoB, Dean, Node, Ashley Duo Air, Villa, Cove, Interact G2	
Wire Management	J-Shape wire manager and table leg wire channel	

*An Oversize Fee has been implemented by freight carriers for all LTL shipments for pallets 8' and over.
 96"-108" - additional \$250.00 | 109" -168" - additional \$350.00 | Per custom pallet

CONFERENCE TABLES

Atlantis

GS-28F-0015W

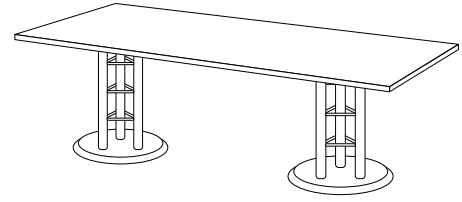

CONFIGURE & PRICE

	MODEL NUMBER	TFL	HPL	1-DAY	5-DAY
Rectangle	ATLS-3660-RT	-	1,056.05	-	-
	ATLS-3666-RT	-	1,083.82	-	-
	ATLS-3672-RT	-	1,103.47	-	-
	ATLS-3678-RT	-	1,176.95	-	-
	ATLS-3684-RT	-	1,226.50	-	-
	ATLS-3696-RT	-	1,273.07	-	-
	ATLS-36108-RT	-	1,547.34	-	-
	ATLS-36120-RT	-	2,102.70	-	-
	ATLS-36144-RT	-	2,221.04	-	-
	ATLS-4278-RT	-	1,229.07	-	-
	ATLS-4284-RT	-	1,352.10	-	-
	ATLS-4296-RT	-	1,434.98	-	-
	ATLS-42108-RT	-	1,657.55	-	-
	ATLS-42120-RT	-	2,169.34	-	-
	ATLS-42144-RT	-	2,338.94	-	-
	ATLS-4884-RT	-	1,556.30	-	-
	ATLS-4896-RT	-	1,625.93	-	-
	ATLS-48108-RT	-	1,930.11	-	-
	ATLS-48120-RT	-	2,453.86	-	-
	ATLS-48144-RT	-	2,596.98	-	-
Race-track	ATLS-3660-RC	-	1,130.81	-	-
	ATLS-3666-RC	-	1,181.22	-	-
	ATLS-3672-RC	-	1,201.72	-	-
	ATLS-3678-RC	-	1,294.01	-	-
	ATLS-3684-RC	-	1,355.95	-	-
	ATLS-3696-RC	-	1,450.36	-	-
	ATLS-36108-RC	-	1,692.58	-	-
	ATLS-36120-RC	-	2,282.98	-	-
	ATLS-36144-RC	-	2,458.56	-	-
	ATLS-4278-RC	-	1,359.79	-	-
	ATLS-4284-RC	-	1,512.73	-	-
	ATLS-4296-RC	-	1,614.83	-	-
	ATLS-42108-RC	-	1,816.04	-	-
	ATLS-42120-RC	-	2,329.12	-	-
	ATLS-42144-RC	-	2,587.14	-	-

CONFERENCE TABLES

Atlantis

GS-28F-0015W

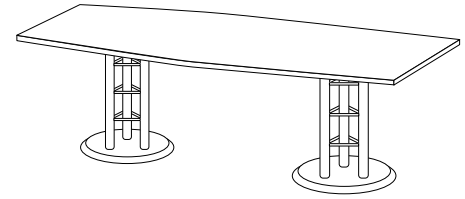

CONFIGURE & PRICE

	MODEL NUMBER	TFL	HPL	1-DAY	5-DAY
Racetrack	ATLS-4884-RC	-	1,725.90	-	-
	ATLS-4896-RC	-	1,851.51	-	-
	ATLS-48108-RC	-	2,116.80	-	-
	ATLS-48120-RC	-	2,709.33	-	-
	ATLS-48144-RC	-	2,875.08	-	-
Boat Shape	ATLS-3660-BT	-	1,148.76	-	-
	ATLS-3666-BT	-	1,200.02	-	-
	ATLS-3672-BT	-	1,220.09	-	-
	ATLS-3684-BT	-	1,379.45	-	-
	ATLS-3696-BT	-	1,479.41	-	-
	ATLS-36108-BT	-	1,686.18	-	-
	ATLS-36120-BT	-	2,285.12	-	-
	ATLS-36144-BT	-	2,487.18	-	-
	ATLS-4278-BT	-	1,384.56	-	-
	ATLS-4284-BT	-	1,543.92	-	-
	ATLS-4296-BT	-	1,651.14	-	-
	ATLS-42108-BT	-	1,854.49	-	-
	ATLS-42120-BT	-	2,371.41	-	-
	ATLS-42144-BT	-	2,640.12	-	-
	ATLS-4884-BT	-	1,760.94	-	-
	ATLS-4896-BT	-	1,890.80	-	-
	ATLS-48108-BT	-	2,160.80	-	-
	ATLS-48120-BT	-	2,760.59	-	-
ATLS-48144-BT	-	2,934.04	-	-	
Oval	ATLS-3660-OV	-	1,198.31	-	-
	ATLS-3666-OV	-	1,257.26	-	-
	ATLS-3672-OV	-	1,317.07	-	-
	ATLS-3684-OV	-	1,456.77	-	-
	ATLS-3696-OV	-	1,562.29	-	-
	ATLS-36108-OV	-	1,784.86	-	-
	ATLS-36120-OV	-	2,403.88	-	-
	ATLS-36144-OV	-	2,629.44	-	-
	ATLS-4278-OV	-	1,460.61	-	-
	ATLS-4284-OV	-	1,639.61	-	-
	ATLS-4296-OV	-	1,760.50	-	-

CONFERENCE TABLES

Atlantis

GS-28F-0015W

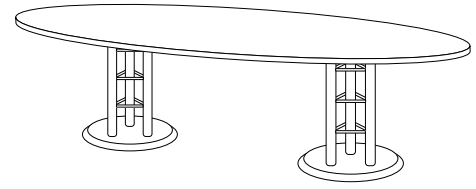

		CONFIGURE & PRICE			
	MODEL NUMBER	TFL	HPL	1-DAY	5-DAY
Oval	ATLS-42108-OV	-	1,972.40	-	-
	ATLS-42120-OV	-	2,500.86	-	-
	ATLS-42144-OV	-	2,800.32	-	-
	ATLS-4884-OV	-	1,863.47	-	-
	ATLS-4896-OV	-	2,002.73	-	-
	ATLS-48108-OV	-	2,295.37	-	-
	ATLS-48120-OV	-	2,914.81	-	-
	ATLS-48144-OV	-	3,113.89	-	-

Atlantis Options

MODEL NUMBER	DESCRIPTION	ADD-ON	
		TABLES UP TO 96" LONG	TABLES 108" TO 144" LONG
-42	Bar Height	77.75	116.63
	2 Piece Table Top Standard for sizes over 108"	-	
	1 Piece Table Top for sizes up to 168"	250.34	

Accessories for Conference Tables

OPTION	DESCRIPTION	PRICE
Grommets	Round or Rectangle	Visit SpecialT.net
Power & Data Management	Burele, EZ Power, Nacre, MhoB, Dean, Node, Ashley Duo Air, Villa, Cove, Interact G2	
Wire Management	J-Shape wire manager and table leg wire channel	

*An Oversize Fee has been implemented by freight carriers for all LTL shipments for pallets 8' and over.
 96"-108" - additional \$250.00 | 109" -168" - additional \$350.00 | Per custom pallet

CONFERENCE TABLES
Benton

GS-28F-0015W

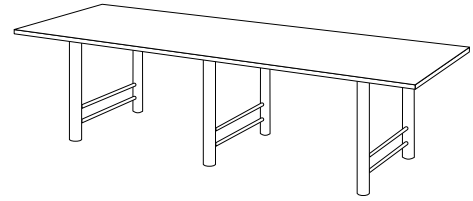

		CONFIGURE & PRICE				
		MODEL NUMBER	TFL	HPL	1-DAY	5-DAY
Rectangle		BNTN-3660-RT	-	539.56	-	-
		BNTN-3666-RT	-	607.91	-	-
		BNTN-3672-RT	-	692.07	-	-
		BNTN-3678-RT	-	763.84	-	-
		BNTN-3684-RT	-	815.10	-	-
		BNTN-3696-RT	-	861.24	-	-
		BNTN-36108-RT	-	1,258.12	-	-
		BNTN-36120-RT	-	1,397.38	-	-
		BNTN-36144-RT	-	1,638.75	-	-
		BNTN-4278-RT	-	856.12	-	-
		BNTN-4284-RT	-	979.15	-	-
		BNTN-4296-RT	-	1,061.18	-	-
		BNTN-42108-RT	-	1,424.73	-	-
		BNTN-42120-RT	-	1,521.70	-	-
		BNTN-42144-RT	-	1,832.28	-	-
		BNTN-4884-RT	-	1,024.01	-	-
		BNTN-4896-RT	-	1,093.64	-	-
		BNTN-48108-RT	-	1,538.79	-	-
		BNTN-48120-RT	-	1,666.10	-	-
		BNTN-48144-RT	-	1,951.90	-	-
Race-track		BNTN-3660-RC	-	718.98	-	-
		BNTN-3666-RC	-	769.39	-	-
		BNTN-3672-RC	-	789.47	-	-
		BNTN-3678-RC	-	881.32	-	-
		BNTN-3684-RC	-	944.12	-	-
		BNTN-3696-RC	-	1,039.39	-	-
		BNTN-36108-RC	-	1,403.37	-	-
		BNTN-36120-RC	-	1,578.52	-	-
		BNTN-36144-RC	-	1,876.71	-	-
		BNTN-4278-RC	-	984.28	-	-
		BNTN-4284-RC	-	1,139.36	-	-
		BNTN-4296-RC	-	1,241.45	-	-
		BNTN-42108-RC	-	1,582.37	-	-
		BNTN-42120-RC	-	1,681.47	-	-
		BNTN-42144-RC	-	2,080.48	-	-

CONFERENCE TABLES
Benton

GS-28F-0015W

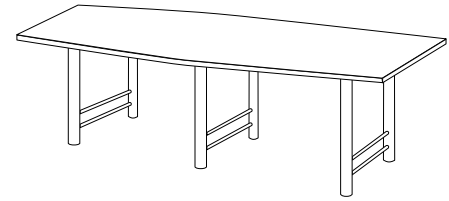

		CONFIGURE & PRICE			
	MODEL NUMBER	TFL	HPL	1-DAY	5-DAY
Racetrack	BNTN-4884-RC	-	1,194.46	-	-
	BNTN-4896-RC	-	1,319.64	-	-
	BNTN-48108-RC	-	1,724.62	-	-
	BNTN-48120-RC	-	1,923.70	-	-
	BNTN-48144-RC	-	2,229.15	-	-
Boat Shape	BNTN-3660-BT	-	736.93	-	-
	BNTN-3666-BT	-	787.77	-	-
	BNTN-3672-BT	-	808.27	-	-
	BNTN-3684-BT	-	969.33	-	-
	BNTN-3696-BT	-	1,066.73	-	-
	BNTN-36108-BT	-	1,274.78	-	-
	BNTN-36120-BT	-	1,578.94	-	-
	BNTN-36144-BT	-	1,904.05	-	-
	BNTN-4278-BT	-	1,011.62	-	-
	BNTN-4284-BT	-	1,169.68	-	-
	BNTN-4296-BT	-	1,276.06	-	-
	BNTN-42108-BT	-	1,622.52	-	-
	BNTN-42120-BT	-	1,723.77	-	-
	BNTN-42144-BT	-	2,133.46	-	-
	BNTN-4884-BT	-	1,227.79	-	-
	BNTN-4896-BT	-	1,358.09	-	-
	BNTN-48108-BT	-	1,769.90	-	-
	BNTN-48120-BT	-	1,973.26	-	-
	BNTN-48144-BT	-	2,289.39	-	-
Oval	BNTN-3660-OV	-	786.48	-	-
	BNTN-3666-OV	-	844.58	-	-
	BNTN-3672-OV	-	905.67	-	-
	BNTN-3684-OV	-	1,046.23	-	-
	BNTN-3696-OV	-	1,150.46	-	-
	BNTN-36108-OV	-	1,372.18	-	-
	BNTN-36120-OV	-	1,698.56	-	-
	BNTN-36144-OV	-	2,047.59	-	-
	BNTN-4278-OV	-	1,087.66	-	-
	BNTN-4284-OV	-	1,265.80	-	-
	BNTN-4296-OV	-	1,384.56	-	-

CONFERENCE TABLES
Benton

GS-28F-0015W

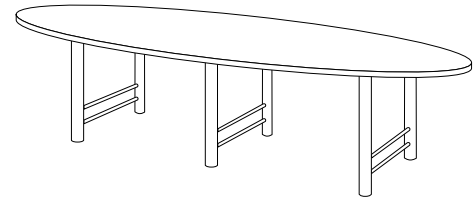

		CONFIGURE & PRICE			
	MODEL NUMBER	TFL	HPL	1-DAY	5-DAY
Oval	BNTN-42108-OV	-	1,740.43	-	-
	BNTN-42120-OV	-	1,852.35	-	-
	BNTN-42144-OV	-	2,293.23	-	-
	BNTN-4884-OV	-	1,331.60	-	-
	BNTN-4896-OV	-	1,469.58	-	-
	BNTN-48108-OV	-	1,904.91	-	-
	BNTN-48120-OV	-	2,127.90	-	-
	BNTN-48144-OV	-	2,468.38	-	-

Benton Options

MODEL NUMBER	DESCRIPTION	ADD-ON
	2 Piece Table Top Standard for sizes over 108"	-
	1 Piece Table Top for sizes up to 168"	250.34

Accessories for Conference Tables

OPTION	DESCRIPTION	PRICE
Grommets	Round or Rectangle	Visit SpecialT.net
Power & Data Management	Burele, EZ Power, Nacre, MhoB, Dean, Node, Ashley Duo Air, Villa, Cove, Interact G2	
Wire Management	J-Shape wire manager and table leg wire channel	

*An Oversize Fee has been implemented by freight carriers for all LTL shipments for pallets 8' and over.
 96"-108" - additional \$250.00 | 109" -168" - additional \$350.00 | Per custom pallet

CONFERENCE TABLES
Connect

GS-28F-0015W

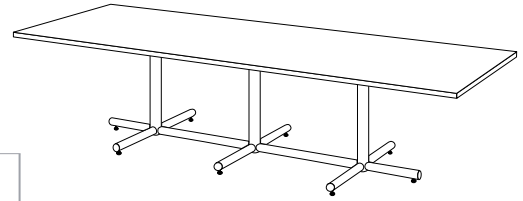

CONFIGURE & PRICE

	MODEL NUMBER	TFL	HPL	1-DAY	5-DAY
Rectangle	CNCT-3660-RT	-	694.63	-	-
	CNCT-3666-RT	-	726.67	-	-
	CNCT-3672-RT	-	748.89	-	-
	CNCT-3678-RT	-	821.09	-	-
	CNCT-3684-RT	-	871.07	-	-
	CNCT-3696-RT	-	1,068.01	-	-
	CNCT-36108-RT	-	1,343.98	-	-
	CNCT-36120-RT	-	1,482.82	-	-
	CNCT-36144-RT	-	1,750.68	-	-
	CNCT-4278-RT	-	874.06	-	-
	CNCT-4284-RT	-	996.24	-	-
	CNCT-4296-RT	-	1,231.20	-	-
	CNCT-42108-RT	-	1,453.35	-	-
	CNCT-42120-RT	-	1,548.19	-	-
	CNCT-42144-RT	-	1,869.44	-	-
	CNCT-4884-RT	-	1,041.52	-	-
	CNCT-4896-RT	-	1,262.81	-	-
	CNCT-48108-RT	-	1,566.98	-	-
	CNCT-48120-RT	-	1,693.44	-	-
	CNCT-48144-RT	-	1,990.35	-	-
Race-track	CNCT-3660-RC	-	776.23	-	-
	CNCT-3666-RC	-	827.06	-	-
	CNCT-3672-RC	-	845.86	-	-
	CNCT-3678-RC	-	937.71	-	-
	CNCT-3684-RC	-	1,000.08	-	-
	CNCT-3696-RC	-	1,247.01	-	-
	CNCT-36108-RC	-	1,487.09	-	-
	CNCT-36120-RC	-	1,663.10	-	-
	CNCT-36144-RC	-	1,990.35	-	-
	CNCT-4278-RC	-	1,003.51	-	-
	CNCT-4284-RC	-	1,157.30	-	-
	CNCT-4296-RC	-	1,409.77	-	-
	CNCT-42108-RC	-	1,611.42	-	-
	CNCT-42120-RC	-	1,709.24	-	-
	CNCT-42144-RC	-	2,118.08	-	-

CONFERENCE TABLES

Connect

GS-28F-0015W

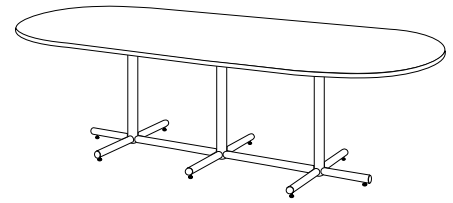

CONFIGURE & PRICE

	MODEL NUMBER	TFL	HPL	1-DAY	5-DAY
Racetrack	CNCT-4884-RC	-	1,213.26	-	-
	CNCT-4896-RC	-	1,489.23	-	-
	CNCT-48108-RC	-	1,753.67	-	-
	CNCT-48120-RC	-	1,951.04	-	-
	CNCT-48144-RC	-	2,267.17	-	-
Boat Shape	CNCT-3660-BT	-	793.74	-	-
	CNCT-3666-BT	-	845.01	-	-
	CNCT-3672-BT	-	865.94	-	-
	CNCT-3684-BT	-	1,025.29	-	-
	CNCT-3696-BT	-	1,123.12	-	-
	CNCT-36108-BT	-	1,482.40	-	-
	CNCT-36120-BT	-	1,664.82	-	-
	CNCT-36144-BT	-	2,017.68	-	-
	CNCT-4278-BT	-	1,029.14	-	-
	CNCT-4284-BT	-	1,188.91	-	-
	CNCT-4296-BT	-	1,445.66	-	-
	CNCT-42108-BT	-	1,650.72	-	-
	CNCT-42120-BT	-	1,750.68	-	-
	CNCT-42144-BT	-	2,170.20	-	-
	CNCT-4884-BT	-	1,247.44	-	-
	CNCT-4896-BT	-	1,527.25	-	-
	CNCT-48108-BT	-	1,797.67	-	-
	CNCT-48120-BT	-	2,001.87	-	-
CNCT-48144-BT	-	2,326.98	-	-	
Oval	CNCT-3660-OV	-	843.30	-	-
	CNCT-3666-OV	-	900.98	-	-
	CNCT-3672-OV	-	962.07	-	-
	CNCT-3684-OV	-	1,102.61	-	-
	CNCT-3696-OV	-	1,207.27	-	-
	CNCT-36108-OV	-	1,579.80	-	-
	CNCT-36120-OV	-	1,784.43	-	-
	CNCT-36144-OV	-	2,159.94	-	-
	CNCT-4278-OV	-	1,106.46	-	-
	CNCT-4284-OV	-	1,285.03	-	-
	CNCT-4296-OV	-	1,555.02	-	-

CONFERENCE TABLES

Connect

GS-28F-0015W

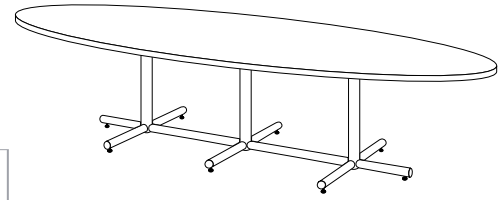

		CONFIGURE & PRICE			
	MODEL NUMBER	TFL	HPL	1-DAY	5-DAY
Oval	CNCT-42108-OV	-	1,768.62	-	-
	CNCT-42120-OV	-	1,880.55	-	-
	CNCT-42144-OV	-	2,331.68	-	-
	CNCT-4884-OV	-	1,350.39	-	-
	CNCT-4896-OV	-	1,639.61	-	-
	CNCT-48108-OV	-	1,932.68	-	-
	CNCT-48120-OV	-	2,156.10	-	-
	CNCT-48144-OV	-	2,505.97	-	-

Connect Options

MODEL NUMBER	DESCRIPTION	ADD-ON
	2 Piece Table Top Standard for sizes over 108"	-
	1 Piece Table Top for sizes up to 168"	250.34

Accessories for Conference Tables

OPTION	DESCRIPTION	PRICE
Grommets	Round or Rectangle	Visit SpecialT.net
Power & Data Management	Burele, EZ Power, Nacre, MhoB, Dean, Node, Ashley Duo Air, Villa, Cove, Interact G2	
Wire Management	J-Shape wire manager and table leg wire channel	

*An Oversize Fee has been implemented by freight carriers for all LTL shipments for pallets 8' and over.
 96"-108" - additional \$250.00 | 109" -168" - additional \$350.00 | Per custom pallet

CONFERENCE TABLES

Olympus

GS-28F-0015W

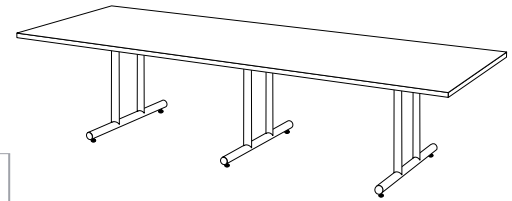

		CONFIGURE & PRICE			
	MODEL NUMBER	TFL	HPL	1-DAY	5-DAY
Rectangle	OLYM-3660-RT	-	589.96	-	-
	OLYM-3666-RT	-	658.75	-	-
	OLYM-3672-RT	-	711.29	-	-
	OLYM-3678-RT	-	783.06	-	-
	OLYM-3684-RT	-	833.47	-	-
	OLYM-3696-RT	-	880.46	-	-
	OLYM-36108-RT	-	1,286.31	-	-
	OLYM-36120-RT	-	1,426.86	-	-
	OLYM-36144-RT	-	1,676.35	-	-
	OLYM-4278-RT	-	858.68	-	-
	OLYM-4284-RT	-	982.15	-	-
	OLYM-4296-RT	-	1,064.16	-	-
	OLYM-4218-RT	-	1,430.71	-	-
	OLYM-42120-RT	-	1,527.25	-	-
	OLYM-42144-RT	-	1,839.54	-	-
	OLYM-4884-RT	-	1,046.23	-	-
	OLYM-4896-RT	-	1,115.86	-	-
	OLYM-48108-RT	-	1,572.11	-	-
	OLYM-48120-RT	-	1,701.13	-	-
	OLYM-48144-RT	-	1,996.32	-	-
OLYM-6096-RT	-	1,424.73	-	-	
OLYM-60108-RT	-	1,740.43	-	-	
OLYM-60120-RT	-	2,054.43	-	-	
OLYM-60144-RT	-	2,330.40	-	-	
Racetrack	OLYM-3660-RC	-	737.78	-	-
	OLYM-3666-RC	-	787.77	-	-
	OLYM-3672-RC	-	808.27	-	-
	OLYM-3678-RC	-	900.54	-	-
	OLYM-3684-RC	-	962.92	-	-
	OLYM-3696-RC	-	1,056.91	-	-
	OLYM-36108-RC	-	1,430.71	-	-
	OLYM-36120-RC	-	1,605.86	-	-
	OLYM-36144-RC	-	1,914.30	-	-

CONFERENCE TABLES

Olympus

GS-28F-0015W

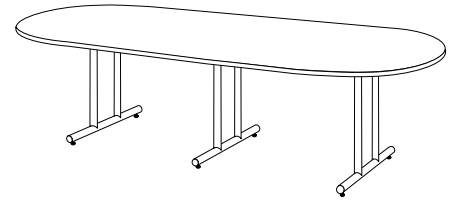

CONFIGURE & PRICE

	MODEL NUMBER	TFL	HPL	1-DAY	5-DAY
Racetrack	OLYM-4278-RC	-	988.98	-	-
	OLYM-4284-RC	-	1,142.77	-	-
	OLYM-4296-RC	-	1,244.88	-	-
	OLYM-42108-RC	-	1,588.34	-	-
	OLYM-42120-RC	-	1,686.18	-	-
	OLYM-42144-RC	-	2,087.31	-	-
	OLYM-4884-RC	-	1,217.11	-	-
	OLYM-4896-RC	-	1,341.84	-	-
	OLYM-48108-RC	-	1,758.80	-	-
	OLYM-48120-RC	-	1,956.59	-	-
	OLYM-48144-RC	-	2,275.28	-	-
	OLYM-6096-RC	-	1,683.18	-	-
	OLYM-60108-RC	-	1,998.89	-	-
	OLYM-60120-RC	-	2,348.77	-	-
	OLYM-60144-RC	-	2,676.86	-	-
Boat Shape	OLYM-3660-BT	-	755.29	-	-
	OLYM-3666-BT	-	806.99	-	-
	OLYM-3672-BT	-	828.78	-	-
	OLYM-3684-BT	-	988.55	-	-
	OLYM-3696-BT	-	1,086.81	-	-
	OLYM-36108-BT	-	1,294.01	-	-
	OLYM-36120-BT	-	1,606.29	-	-
	OLYM-36144-BT	-	1,989.49	-	-
	OLYM-4278-BT	-	1,015.03	-	-
	OLYM-4284-BT	-	1,173.95	-	-
	OLYM-4296-BT	-	1,280.76	-	-
	OLYM-42108-BT	-	1,627.22	-	-
	OLYM-42120-BT	-	1,728.90	-	-
	OLYM-42144-BT	-	2,141.15	-	-
	OLYM-4884-BT	-	1,251.28	-	-
	OLYM-4896-BT	-	1,381.15	-	-
	OLYM-48108-BT	-	1,802.38	-	-
	OLYM-48120-BT	-	2,007.44	-	-
OLYM-48144-BT	-	2,333.39	-	-	

CONFERENCE TABLES

Olympus

GS-28F-0015W

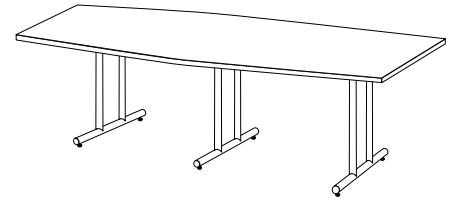

CONFIGURE & PRICE

	MODEL NUMBER	TFL	HPL	1-DAY	5-DAY
Boat Shape	OLYM-6096-BT	-	1,736.16	-	-
	OLYM-60108-BT	-	2,058.27	-	-
	OLYM-60120-BT	-	2,414.56	-	-
	OLYM-60144-BT	-	2,750.77	-	-
Oval	OLYM-3660-OV	-	805.70	-	-
	OLYM-3666-OV	-	862.10	-	-
	OLYM-3672-OV	-	924.04	-	-
	OLYM-3684-OV	-	1,065.02	-	-
	OLYM-3696-OV	-	1,169.68	-	-
	OLYM-36108-OV	-	1,392.26	-	-
	OLYM-36120-OV	-	1,728.04	-	-
	OLYM-36144-OV	-	2,132.60	-	-
	OLYM-4278-OV	-	1,091.08	-	-
	OLYM-4284-OV	-	1,270.08	-	-
	OLYM-4296-OV	-	1,388.84	-	-
	OLYM-42108-OV	-	1,746.41	-	-
	OLYM-42120-OV	-	1,858.76	-	-
	OLYM-42144-OV	-	2,301.35	-	-
	OLYM-4884-OV	-	1,352.96	-	-
	OLYM-4896-OV	-	1,492.22	-	-
	OLYM-48108-OV	-	1,939.08	-	-
	OLYM-48120-OV	-	2,162.51	-	-
	OLYM-48144-OV	-	2,513.24	-	-
	OLYM-6096-OV	-	1,890.80	-	-
OLYM-60108-OV	-	2,236.84	-	-	
OLYM-60120-OV	-	2,613.63	-	-	
OLYM-60144-OV	-	2,969.92	-	-	

CONFERENCE TABLES

Olympus

GS-28F-0015W

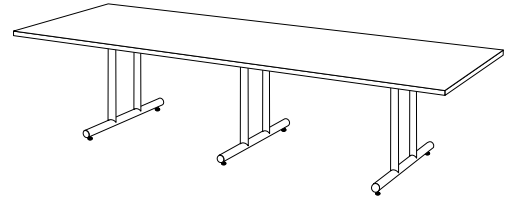

Olympus Options

MODEL NUMBER	DESCRIPTION	ADD-ON	
		TABLES UP TO 96" LONG	TABLES 108" TO 144" LONG
-42	Bar Height	107.66	161.48
-CA	Casters	32.47	48.70
	2 Piece Table Top Standard for sizes over 108"	-	
	1 Piece Table Top for sizes up to 168"	250.34	

Accessories for Conference Tables

OPTION	DESCRIPTION	PRICE
Grommets	Round or Rectangle	Visit SpecialT.net
Power & Data Management	Burele, EZ Power, Nacre, MhoB, Dean, Node, Ashley Duo Air, Villa, Cove, Interact G2	
Wire Management	J-Shape wire manager and table leg wire channel	

*An Oversize Fee has been implemented by freight carriers for all LTL shipments for pallets 8' and over.
 96"-108" - additional \$250.00 | 109" -168" - additional \$350.00 | Per custom pallet

CONFERENCE TABLES

Sienna 2TL

GS-28F-0015W

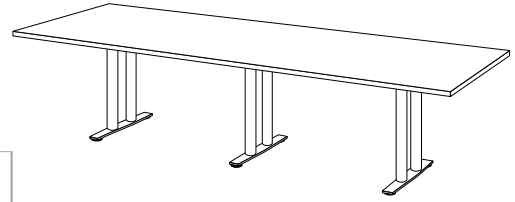

CONFIGURE & PRICE

	MODEL NUMBER	TFL	HPL	1-DAY	5-DAY
Rectangle	SIENTL-3660-RT	-	789.47	-	-
	SIENTL-3666-RT	-	839.03	-	-
	SIENTL-3672-RT	-	843.30	-	-
	SIENTL-3678-RT	-	892.43	-	-
	SIENTL-3684-RT	-	951.81	-	-
	SIENTL-3696-RT	-	988.55	-	-
	SIENTL-36108-RT	-	1,399.95	-	-
	SIENTL-36120-RT	-	1,408.92	-	-
	SIENTL-36144-RT	-	1,481.54	-	-
	SIENTL-4278-RT	-	1,000.94	-	-
	SIENTL-4284-RT	-	1,035.97	-	-
	SIENTL-4296-RT	-	1,075.27	-	-
	SIENTL-42108-RT	-	1,548.19	-	-
	SIENTL-42120-RT	-	1,562.71	-	-
	SIENTL-42144-RT	-	1,701.13	-	-
	SIENTL-4884-RT	-	1,078.27	-	-
	SIENTL-4896-RT	-	1,097.06	-	-
	SIENTL-48108-RT	-	1,590.48	-	-
SIENTL-48120-RT	-	1,660.97	-	-	
SIENTL-48144-RT	-	1,745.13	-	-	
Racetrack	SIENTL-3660-RC	-	989.83	-	-
	SIENTL-3672-RC	-	1,043.23	-	-
	SIENTL-3684-RC	-	1,126.96	-	-
	SIENTL-3696-RC	-	1,194.46	-	-
	SIENTL-36108-RC	-	1,420.45	-	-
	SIENTL-36120-RC	-	1,429.85	-	-
	SIENTL-36144-RC	-	1,831.85	-	-
	SIENTL-4284-RC	-	1,263.24	-	-
	SIENTL-4296-RC	-	1,323.91	-	-
	SIENTL-42108-RC	-	1,580.23	-	-
	SIENTL-42120-RC	-	1,590.91	-	-
	SIENTL-42144-RC	-	2,022.81	-	-
	SIENTL-4884-RC	-	1,248.29	-	-
SIENTL-4896-RC	-	1,323.91	-	-	

CONFERENCE TABLES
Sienna 2TL

GS-28F-0015W

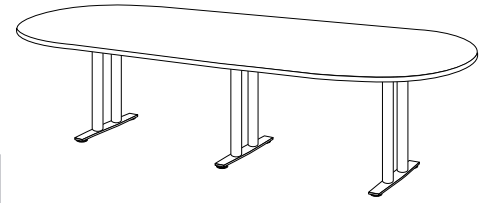

CONFIGURE & PRICE

	MODEL NUMBER	TFL	HPL	1-DAY	5-DAY
Racetrack	SIENTL-48108-RC	-	1,580.23	-	-
	SIENTL-48120-RC	-	1,590.91	-	-
	SIENTL-48144-RC	-	2,022.81	-	-
Boat Shape	SIENTL-3660-BT	-	989.83	-	-
	SIENTL-3672-BT	-	1,043.23	-	-
	SIENTL-3684-BT	-	1,126.96	-	-
	SIENTL-3696-BT	-	1,194.46	-	-
	SIENTL-36108-BT	-	1,420.45	-	-
	SIENTL-36120-BT	-	1,429.85	-	-
	SIENTL-36144-BT	-	1,831.85	-	-
	SIENTL-4284-BT	-	1,263.24	-	-
	SIENTL-4296-BT	-	1,323.91	-	-
	SIENTL-42108-BT	-	1,580.23	-	-
	SIENTL-42120-BT	-	1,590.91	-	-
	SIENTL-42144-BT	-	2,022.81	-	-
	SIENTL-4884-BT	-	1,248.29	-	-
	SIENTL-4896-BT	-	1,323.91	-	-
	SIENTL-48108-BT	-	1,580.23	-	-
SIENTL-48120-BT	-	1,590.91	-	-	
SIENTL-48144-BT	-	2,022.81	-	-	

Sienna 2TL Options

MODEL NUMBER	DESCRIPTION	ADD-ON
-42	Bar Height	107.66
	2 Piece Table Top Standard for sizes over 108"	-
	1 Piece Table Top for sizes up to 168"	250.34

Accessories for Conference Tables

OPTION	DESCRIPTION	PRICE
Grommets	Round or Rectangle	Visit SpecialT.net
Power & Data Management	Burele, EZ Power, Nacre, MhoB, Dean, Node, Ashley Duo Air, Villa, Cove, Interact G2	
Wire Management	J-Shape wire manager and table leg wire channel	

*An Oversize Fee has been implemented by freight carriers for all LTL shipments for pallets 8' and over.
96"-108" - additional \$250.00 | 109" -168" - additional \$350.00 | Per custom pallet

CONFERENCE TABLES
Sienna 4X

GS-28F-0015W

CONFIGURE & PRICE

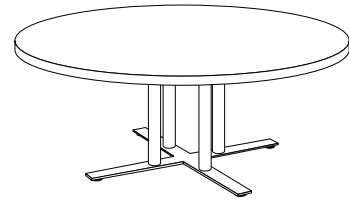

	MODEL NUMBER	TFL	HPL	1-DAY	5-DAY
Round	SIENX-54	662.59	735.65	-	-
	SIENX-60	908.23	1,009.06	-	-
	SIENX-66	1,276.06	1,417.46	-	-
	SIENX-72	-	1,475.13	-	-
Square	SIENX-5454	624.57	694.63	-	-
	SIENX-6060	908.23	967.19	-	-

Sienna 4X Options

MODEL NUMBER	DESCRIPTION	ADD-ON
-SC	Skate Casters	54.68
-42	Bar Height	107.66
-CUSTHT1	Custom Height between 5" - 28.99"	116.20
-CUSTHT2	Custom Height between 29" - 42"	223.85

Accessories for Conference Tables

OPTION	DESCRIPTION	PRICE
Grommets	Round or Rectangle	Visit SpecialT.net
Power & Data Management	Burele, EZ Power, Nacre, MhoB, Dean, Node, Ashley Duo Air, Villa, Cove, Interact G2	
Wire Management	J-Shape wire manager and table leg wire channel	

CONFERENCE TABLES
Sienna Conference

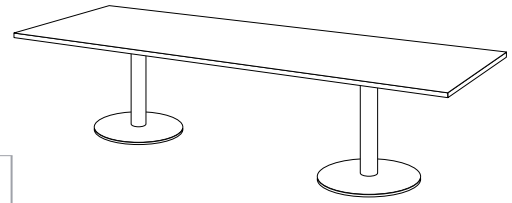

GS-28F-0015W

CONFIGURE & PRICE

	MODEL NUMBER	TFL	HPL	1-DAY	5-DAY
Rectangle	SIEN-2460-RT	611.76	679.25	-	-
	SIEN-2472-RT	655.34	727.53	-	-
	SIEN-2484-RT	710.87	789.47	-	-
	SIEN-2496-RT	761.28	845.44	-	-
	SIEN-24108-RT	-	1,225.22	-	-
	SIEN-24120-RT	-	1,238.89	-	-
	SIEN-3060-RT	751.02	834.76	-	-
	SIEN-3072-RT	795.46	884.74	-	-
	SIEN-3084-RT	859.10	953.94	-	-
	SIEN-3096-RT	915.50	1,017.17	-	-
	SIEN-30108-RT	-	1,228.63	-	-
	SIEN-30120-RT	-	1,472.14	-	-
	SIEN-3660-RT	-	989.83	-	-
	SIEN-3672-RT	-	1,047.07	-	-
	SIEN-3684-RT	-	1,126.96	-	-
	SIEN-3696-RT	-	1,194.46	-	-
	SIEN-36108-RT	-	1,420.45	-	-
	SIEN-36120-RT	-	1,429.85	-	-
	SIEN-36144-RT	-	1,831.85	-	-
	SIEN-4284-RT	-	1,248.29	-	-
SIEN-4296-RT	-	1,323.91	-	-	
SIEN-42108-RT	-	1,580.23	-	-	
SIEN-42120-RT	-	1,590.91	-	-	
SIEN-42144-RT	-	2,022.81	-	-	
Racetrack	SIEN-2460-RC	-	751.02	-	-
	SIEN-2472-RC	-	805.28	-	-
	SIEN-2484-RC	-	865.51	-	-
	SIEN-2496-RC	-	913.79	-	-
	SIEN-24108-RC	-	1,308.96	-	-
	SIEN-24120-RC	-	1,312.37	-	-
	SIEN-3060-RC	-	936.43	-	-
	SIEN-3072-RC	-	977.44	-	-
	SIEN-3084-RC	-	1,056.91	-	-
	SIEN-3096-RC	-	1,102.19	-	-

CONFERENCE TABLES
Sienna Conference

GS-28F-0015W

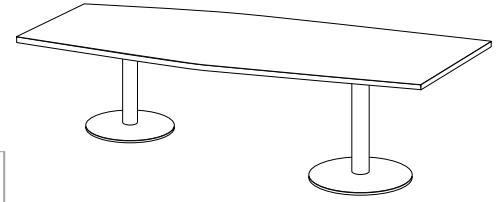

		CONFIGURE & PRICE			
	MODEL NUMBER	TFL	HPL	1-DAY	5-DAY
Racetrack	SIEN-30108-RC	-	1,423.01	-	-
	SIEN-30120-RC	-	1,601.59	-	-
	SIEN-3660-RC	-	989.83	-	-
	SIEN-3672-RC	-	1,047.07	-	-
	SIEN-3684-RC	-	1,126.96	-	-
	SIEN-3696-RC	-	1,194.46	-	-
	SIEN-36108-RC	-	1,420.45	-	-
	SIEN-36120-RC	-	1,429.85	-	-
	SIEN-36144-RC	-	1,831.85	-	-
	SIEN-4284-RC	-	1,248.29	-	-
	SIEN-4296-RC	-	1,323.91	-	-
	SIEN-42108-RC	-	1,580.23	-	-
	SIEN-42120-RC	-	1,590.91	-	-
	SIEN-42144-RC	-	2,022.81	-	-
Boat Shape	SIEN-2460-BT	-	679.25	-	-
	SIEN-2472-BT	-	727.53	-	-
	SIEN-2484-BT	-	789.47	-	-
	SIEN-2496-BT	-	845.44	-	-
	SIEN-24108-BT	-	1,225.22	-	-
	SIEN-24120-BT	-	1,238.89	-	-
	SIEN-3060-BT	-	834.76	-	-
	SIEN-3072-BT	-	884.74	-	-
	SIEN-3084-BT	-	953.94	-	-
	SIEN-3096-BT	-	1,017.17	-	-
	SIEN-30108-BT	-	1,228.63	-	-
	SIEN-30120-BT	-	1,472.14	-	-
	SIEN-3660-BT	-	989.83	-	-
	SIEN-3672-BT	-	1,047.07	-	-
	SIEN-3684-BT	-	1,126.96	-	-
	SIEN-3696-BT	-	1,194.46	-	-
	SIEN-36108-BT	-	1,420.45	-	-
	SIEN-36120-BT	-	1,429.85	-	-
SIEN-36144-BT	-	1,831.85	-	-	

CONFERENCE TABLES
Sienna Conference

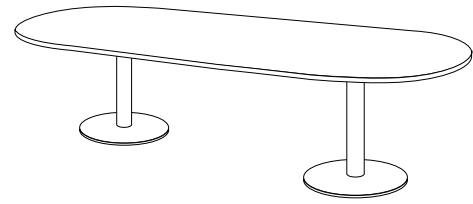

GS-28F-0015W

		CONFIGURE & PRICE			
	MODEL NUMBER	TFL	HPL	1-DAY	5-DAY
Boat Shape	SIEN-4284-BT	-	1,248.29	-	-
	SIEN-4296-BT	-	1,323.91	-	-
	SIEN-42108-BT	-	1,580.23	-	-
	SIEN-42120-BT	-	1,590.91	-	-
	SIEN-42144-BT	-	2,022.81	-	-

Sienna Options

MODEL NUMBER	DESCRIPTION	ADD-ON
	2 Piece Table Top Standard for sizes over 108"	-
	1 Piece Table Top for sizes up to 168"	250.34

Accessories for Conference Tables

OPTION	DESCRIPTION	PRICE
Grommets	Round or Rectangle	Visit SpecialT.net
Power & Data Management	Burele, EZ Power, Nacre, MhoB, Dean, Node, Ashley Duo Air, Villa, Cove, Interact G2	
Wire Management	J-Shape wire manager and table leg wire channel	

*An Oversize Fee has been implemented by freight carriers for all LTL shipments for pallets 8' and over.
 96"-108" - additional \$250.00 | 109" -168" - additional \$350.00 | Per custom pallet

CONFERENCE TABLES
Sienna Rectangle

GS-28F-0015W

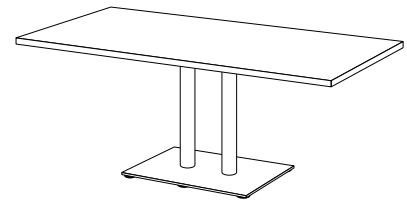

		CONFIGURE & PRICE			
	MODEL NUMBER	TFL	HPL	1-DAY	5-DAY
Rectangle	SIENPL-3660-RT	-	799.73	-	-
	SIENPL-3666-RT	-	849.28	-	-
	SIENPL-3672-RT	-	853.98	-	-
	SIENPL-3678-RT	-	903.54	-	-
	SIENPL-4278-RT	-	1,012.05	-	-

Sienna Rectangle Options

MODEL NUMBER	DESCRIPTION	ADD-ON
-42	Bar Height	53.83

Accessories for Conference Tables

OPTION	DESCRIPTION	PRICE
Grommets	Round or Rectangle	Visit SpecialT.net
Power & Data Management	Burele, EZ Power, Nacre, MhoB, Dean, Node, Ashley Duo Air, Villa, Cove, Interact G2	
Wire Management	J-Shape wire manager and table leg wire channel	

CONFERENCE TABLES
Structure 4X

GS-28F-0015W

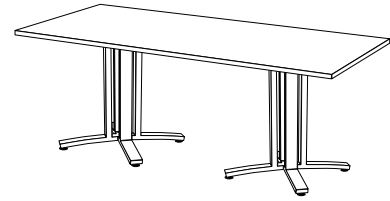

		CONFIGURE & PRICE				
		MODEL NUMBER	TFL	HPL	1-DAY	5-DAY
Rectangle		STRU-4X-2460-RT	647.21	718.98	-	-
		STRU-4X-2466-RT	664.30	737.35	-	-
		STRU-4X-2472-RT	664.30	758.71	-	-
		STRU-4X-2484-RT	683.53	851.42	-	-
		STRU-4X-2496-RT	765.97	945.40	-	-
		STRU-4X-3060-RT	850.14	786.48	-	-
		STRU-4X-3066-RT	707.45	802.72	-	-
		STRU-4X-3072-RT	722.40	833.90	-	-
		STRU-4X-3084-RT	750.60	978.72	-	-
		STRU-4X-3096-RT	880.46	1,060.75	-	-
		STRU-4X-3660-RT	-	901.82	-	-
		STRU-4X-3666-RT	-	941.56	-	-
		STRU-4X-3672-RT	-	1,032.55	-	-
		STRU-4X-3684-RT	-	1,081.68	-	-
		STRU-4X-3696-RT	-	1,164.13	-	-
		STRU-4X-36108-RT	-	1,367.48	-	-
		STRU-4X-36120-RT	-	1,505.89	-	-
		STRU-4X-4272-RT	-	1,060.75	-	-
		STRU-4X-4284-RT	-	1,237.18	-	-
		STRU-4X-4296-RT	-	1,314.51	-	-
		STRU-4X-42108-RT	-	1,492.22	-	-
		STRU-4X-42120-RT	-	1,569.12	-	-
		STRU-4X-4884-RT	-	1,279.90	-	-
		STRU-4X-4896-RT	-	1,348.25	-	-
	STRU-4X-48108-RT	-	1,604.57	-	-	
	STRU-4X-48120-RT	-	1,724.19	-	-	
Racetrack		STRU-4X-2460-RC	-	775.38	-	-
		STRU-4X-2466-RC	-	802.72	-	-
		STRU-4X-2472-RC	-	865.94	-	-
		STRU-4X-2484-RC	-	979.15	-	-
		STRU-4X-2496-RC	-	1,047.51	-	-
		STRU-4X-3060-RC	-	858.68	-	-
		STRU-4X-3066-RC	-	874.91	-	-
		STRU-4X-3072-RC	-	913.79	-	-
		STRU-4X-3084-RC	-	1,124.40	-	-

CONFERENCE TABLES
Structure 4X

GS-28F-0015W

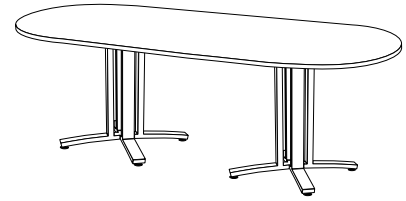

CONFIGURE & PRICE

	MODEL NUMBER	TFL	HPL	1-DAY	5-DAY
Racetrack	STRU-4X-3096-RC	-	1,180.36	-	-
	STRU-4X-3660-RC	-	982.99	-	-
	STRU-4X-3666-RC	-	1,068.87	-	-
	STRU-4X-3672-RC	-	1,086.38	-	-
	STRU-4X-3684-RC	-	1,241.45	-	-
	STRU-4X-3696-RC	-	1,296.56	-	-
	STRU-4X-36108-RC	-	1,527.25	-	-
	STRU-4X-36120-RC	-	1,665.24	-	-
	STRU-4X-4272-RC	-	1,181.22	-	-
	STRU-4X-4284-RC	-	1,391.83	-	-
	STRU-4X-4296-RC	-	1,491.80	-	-
	STRU-4X-42108-RC	-	1,686.18	-	-
	STRU-4X-42120-RC	-	1,781.86	-	-
	STRU-4X-4884-RC	-	1,448.22	-	-
	STRU-4X-4896-RC	-	1,530.25	-	-
	STRU-4X-48108-RC	-	1,820.31	-	-
STRU-4X-48120-RC	-	1,975.40	-	-	
Boat Shape	STRU-4X-2460-BT	-	797.16	-	-
	STRU-4X-2466-BT	-	823.65	-	-
	STRU-4X-2472-BT	-	887.73	-	-
	STRU-4X-2484-BT	-	1,013.33	-	-
	STRU-4X-2496-BT	-	1,086.38	-	-
	STRU-4X-3060-BT	-	883.03	-	-
	STRU-4X-3066-BT	-	905.67	-	-
	STRU-4X-3072-BT	-	982.99	-	-
	STRU-4X-3084-BT	-	1,168.40	-	-
	STRU-4X-3096-BT	-	1,228.21	-	-
	STRU-4X-3660-BT	-	1,016.75	-	-
	STRU-4X-3666-BT	-	1,068.87	-	-
	STRU-4X-3672-BT	-	1,106.88	-	-
	STRU-4X-3684-BT	-	1,262.39	-	-
	STRU-4X-3696-BT	-	1,323.48	-	-
	STRU-4X-36108-BT	-	1,557.16	-	-
STRU-4X-36120-BT	-	1,703.69	-	-	
STRU-4X-4272-BT	-	1,197.88	-	-	

CONFERENCE TABLES
Structure 4X

GS-28F-0015W

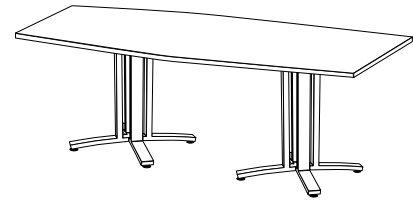

		CONFIGURE & PRICE			
	MODEL NUMBER	TFL	HPL	1-DAY	5-DAY
Boat Shape	STRU-4X-4284-BT	-	1,423.01	-	-
	STRU-4X-4296-BT	-	1,525.97	-	-
	STRU-4X-42108-BT	-	1,720.78	-	-
	STRU-4X-42120-BT	-	1,820.31	-	-
	STRU-4X-4884-BT	-	1,478.98	-	-
	STRU-4X-4896-BT	-	1,568.26	-	-
	STRU-4X-48108-BT	-	1,862.61	-	-
	STRU-4X-48120-BT	-	2,027.51	-	-

Structure 4X Options

MODEL NUMBER	DESCRIPTION	ADD-ON
-42	Bar Height	27.34

Accessories for Conference Tables

OPTION	DESCRIPTION	PRICE
Grommets	Round or Rectangle	Visit SpecialT.net
Power & Data Management	Burele, EZ Power, Nacre, MhoB, Dean, Node, Ashley Duo Air, Villa, Cove, Interact G2	
Wire Management	J-Shape wire manager and table leg wire channel	

*An Oversize Fee has been implemented by freight carriers for all LTL shipments for pallets 8' and over.
 96"-108" - additional \$250.00 | 109" -168" - additional \$350.00 | Per custom pallet

CONFERENCE TABLES
Structure Cube

GS-28F-0015W

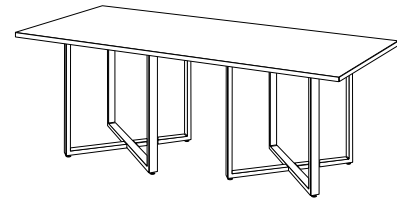

CONFIGURE & PRICE

	MODEL NUMBER	TFL	HPL	1-DAY	5-DAY
Rectangle	STRU-CU-3666-RT	-	938.99	-	-
	STRU-CU-3672-RT	-	991.54	-	-
	STRU-CU-3684-RT	-	1,115.43	-	-
	STRU-CU-3696-RT	-	1,161.99	-	-
	STRU-CU-36108-RT	-	1,320.48	-	-
	STRU-CU-36120-RT	-	1,448.64	-	-
	STRU-CU-4272-RT	-	1,159.00	-	-
	STRU-CU-4284-RT	-	1,354.66	-	-
	STRU-CU-4296-RT	-	1,444.37	-	-
	STRU-CU-42108-RT	-	1,595.61	-	-
	STRU-CU-42120-RT	-	1,629.78	-	-
	STRU-CU-4884-RT	-	1,486.67	-	-
	STRU-CU-4896-RT	-	1,564.85	-	-
	STRU-CU-48108-RT	-	1,724.19	-	-
	STRU-CU-48120-RT	-	1,849.37	-	-
	STRU-CU-6096-RT	-	1,567.84	-	-
	STRU-CU-60108-RT	-	1,697.28	-	-
	STRU-CU-60120-RT	-	1,822.03	-	-
Racetrack	STRU-CU-3666-RC	-	1,009.91	-	-
	STRU-CU-3672-RC	-	1,068.87	-	-
	STRU-CU-3684-RC	-	1,223.94	-	-
	STRU-CU-3696-RC	-	1,279.90	-	-
	STRU-CU-36108-RC	-	1,510.17	-	-
	STRU-CU-36120-RC	-	1,681.90	-	-
	STRU-CU-4272-RC	-	1,215.82	-	-
	STRU-CU-4284-RC	-	1,427.28	-	-
	STRU-CU-4296-RC	-	1,525.97	-	-
	STRU-CU-42108-RC	-	1,720.78	-	-
	STRU-CU-42120-RC	-	1,815.62	-	-
	STRU-CU-4884-RC	-	1,568.26	-	-
	STRU-CU-4896-RC	-	1,650.29	-	-
	STRU-CU-48108-RC	-	1,940.79	-	-
	STRU-CU-48120-RC	-	2,095.86	-	-
STRU-CU-6096-RC	-	1,619.10	-	-	

CONFERENCE TABLES
Structure Cube

GS-28F-0015W

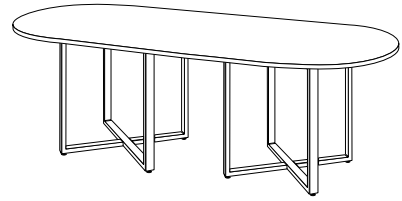

CONFIGURE & PRICE

	MODEL NUMBER	TFL	HPL	1-DAY	5-DAY
Racetrack	STRU-CU-60108-RC	-	1,903.19	-	-
	STRU-CU-60120-RC	-	2,039.48	-	-
Boat Shape	STRU-CU-3672-BT	-	1,089.79	-	-
	STRU-CU-3684-BT	-	1,246.16	-	-
	STRU-CU-3696-BT	-	1,305.53	-	-
	STRU-CU-36108-BT	-	1,543.92	-	-
	STRU-CU-36120-BT	-	1,717.36	-	-
	STRU-CU-4272-BT	-	1,237.18	-	-
	STRU-CU-4284-BT	-	1,456.77	-	-
	STRU-CU-4296-BT	-	1,560.15	-	-
	STRU-CU-42108-BT	-	1,754.95	-	-
	STRU-CU-42120-BT	-	1,854.49	-	-
	STRU-CU-4884-BT	-	1,599.46	-	-
	STRU-CU-4896-BT	-	1,689.59	-	-
	STRU-CU-48108-BT	-	1,987.78	-	-
	STRU-CU-48120-BT	-	2,147.56	-	-
	STRU-CU-6096-BT	-	1,650.29	-	-
	STRU-CU-60108-BT	-	1,949.33	-	-
STRU-CU-60120-BT	-	2,106.12	-	-	
Round	STRU-CU-42-RD	652.34	724.97	-	-
	STRU-CU-48-RD	716.42	796.31	-	-
	STRU-CU-54-RD	833.47	925.32	-	-
	STRU-CU-60-RD	891.58	990.69	-	-
	STRU-CU-72-RD	-	1,484.11	-	-

Accessories for Conference Tables

OPTION	DESCRIPTION	PRICE
Grommets	Round or Rectangle	Visit SpecialT.net
Power & Data Management	Burele, EZ Power, Nacre, MhoB, Dean, Node, Ashley Duo Air, Villa, Cove, Interact G2	
Wire Management	J-Shape wire manager and table leg wire channel	

*An Oversize Fee has been implemented by freight carriers for all LTL shipments for pallets 8' and over.
 96"-108" - additional \$250.00 | 109" -168" - additional \$350.00 | Per custom pallet

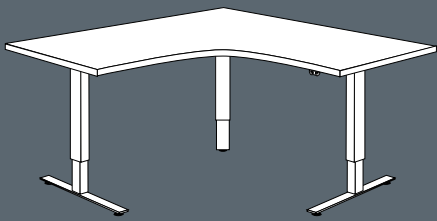

HEIGHT ADJUSTABLE TABLES & BASES

GS-28F-0015W

HEIGHT ADJUSTABLE

Patriot Electric Tables

GS-28F-0015W

Rectangle | 2-Legs | Two Stage

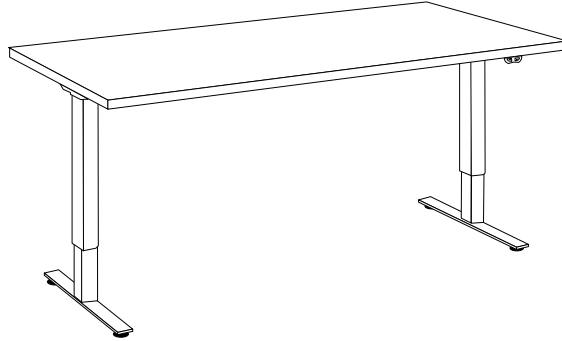

CONFIGURE & PRICE				
MODEL NUMBER	TFL	HPL	1-DAY	5-DAY
PATR-2448	839.46	933.02	-	-
PATR-2454	870.64	967.19	-	-
PATR-2460	881.32	979.58	-	-
PATR-2466	892.43	991.54	-	-
PATR-2472	898.41	998.38	-	-
PATR-2478	948.39	1,054.77	-	-
PATR-2484	995.81	1,106.46	-	-
PATR-3048	867.22	964.20	-	-
PATR-3054	895.85	995.39	-	-
PATR-3060	903.96	1,004.35	-	-
PATR-3066	921.05	1,023.58	-	-
PATR-3072	931.73	1,035.97	-	-
PATR-3078	1,030.84	1,145.33	-	-
PATR-3084	1,087.23	1,207.71	-	-

HEIGHT ADJUSTABLE

Patriot Electric Tables

GS-28F-0015W

Equal Corner | 2-Legs | Two Stage

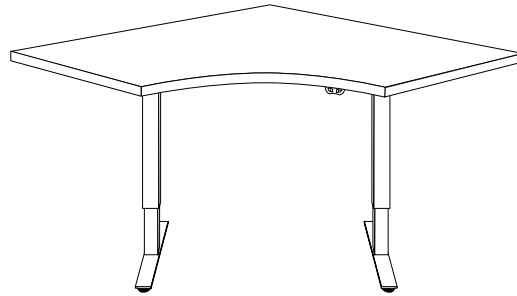

CONFIGURE & PRICE				
MODEL NUMBER	TFL	HPL	1-DAY	5-DAY
PATR-4224-EC	988.12	1,098.34	-	-
PATR-4824-EC	1,009.48	1,121.83	-	-
PATR-4830-EC	930.45	1,033.83	-	-

Equal Corner | 3-Legs | Two Stage

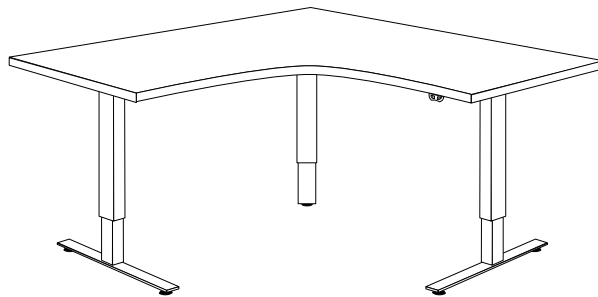

CONFIGURE & PRICE				
MODEL NUMBER	TFL	HPL	1-DAY	5-DAY
PATR-6024-EC	1,467.02	1,629.36	-	-
PATR-6030-EC	1,536.65	1,707.54	-	-
PATR-6624-EC	1,578.94	1,754.53	-	-
PATR-6630-EC	1,641.32	1,822.88	-	-
PATR-7224-EC	1,655.42	1,838.69	-	-
PATR-7230-EC	1,691.73	1,879.27	-	-

HEIGHT ADJUSTABLE

Patriot Electric Tables

GS-28F-0015W

Extended Corner Right | 3-Legs | Two Stage

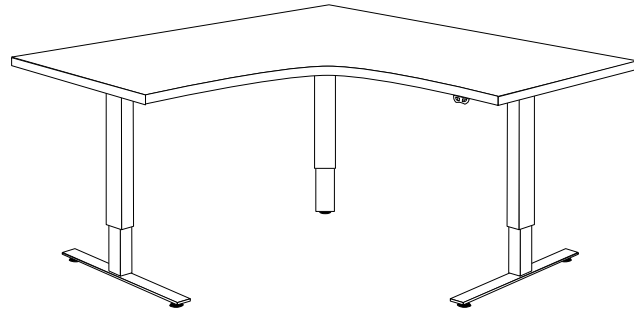

CONFIGURE & PRICE				
MODEL NUMBER	TFL	HPL	1-DAY	5-DAY
PATR-603624-ECR	1,381.15	1,492.65	-	-
PATR-604224-ECR	1,394.40	1,507.61	-	-
PATR-723624-ECR	1,408.92	1,523.84	-	-
PATR-724224-ECR	1,478.98	1,601.59	-	-
PATR-603630-ECR	1,381.15	1,492.65	-	-
PATR-604230-ECR	1,394.40	1,507.61	-	-
PATR-723630-ECR	1,408.92	1,523.84	-	-
PATR-724230-ECR	1,478.98	1,601.59	-	-
PATR-604824-ECR	1,480.26	1,644.74	-	-
PATR-724824-ECR	1,621.24	1,801.09	-	-
PATR-726024-ECR	1,734.03	1,925.83	-	-
PATR-843624-ECR	1,748.12	1,942.07	-	-
PATR-844224-ECR	1,832.28	2,036.05	-	-
PATR-844824-ECR	1,846.38	2,051.00	-	-
PATR-846024-ECR	1,916.87	2,130.04	-	-
PATR-604830-ECR	1,480.26	1,644.74	-	-
PATR-724830-ECR	1,621.24	1,801.09	-	-
PATR-726030-ECR	1,734.03	1,925.83	-	-
PATR-843630-ECR	1,748.12	1,942.07	-	-
PATR-844230-ECR	1,832.28	2,036.05	-	-
PATR-844830-ECR	1,846.38	2,051.00	-	-
PATR-846030-ECR	1,916.87	2,130.04	-	-

HEIGHT ADJUSTABLE

Patriot Electric Tables

GS-28F-0015W

Extended Corner Left | 3-Legs | Two Stage

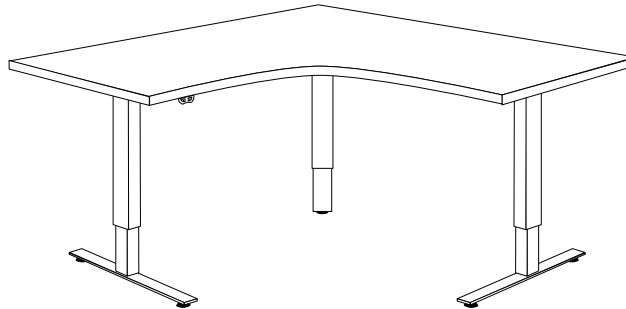

CONFIGURE & PRICE

MODEL NUMBER	TFL	HPL	1-DAY	5-DAY
PATR-603624-ECL	1,381.15	1,492.65	-	-
PATR-604224-ECL	1,394.40	1,507.61	-	-
PATR-723624-ECL	1,408.92	1,523.84	-	-
PATR-724224-ECL	1,478.98	1,601.59	-	-
PATR-603630-ECL	1,381.15	1,492.65	-	-
PATR-604230-ECL	1,394.40	1,507.61	-	-
PATR-723630-ECL	1,408.92	1,523.84	-	-
PATR-724230-ECL	1,478.98	1,601.59	-	-
PATR-604824-ECL	1,480.26	1,644.74	-	-
PATR-724824-ECL	1,621.24	1,801.09	-	-
PATR-726024-ECL	1,734.03	1,925.83	-	-
PATR-843624-ECL	1,748.12	1,942.07	-	-
PATR-844224-ECL	1,832.28	2,036.05	-	-
PATR-844824-ECL	1,846.38	2,051.00	-	-
PATR-846024-ECL	1,916.87	2,130.04	-	-
PATR-604830-ECL	1,480.26	1,644.74	-	-
PATR-724830-ECL	1,621.24	1,801.09	-	-
PATR-726030-ECL	1,734.03	1,925.83	-	-
PATR-843630-ECL	1,748.12	1,942.07	-	-
PATR-844230-ECL	1,832.28	2,036.05	-	-
PATR-844830-ECL	1,846.38	2,051.00	-	-
PATR-846030-ECL	1,916.87	2,130.04	-	-

HEIGHT ADJUSTABLE

Patriot Electric Tables

GS-28F-0015W

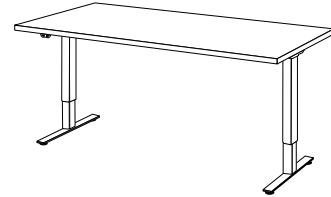

Patriot Electric Options

ITEM	DESCRIPTION	ADD-ON	
		2-LEGS	3-LEGS
Base Option	2S - 2 Stage: 27" - 46" height range (by default)	-	
	3S - 3 Stage: 23" - 48" height range	58.95	65.36
Handset	Standard Up/Down Switch (by default)	-	
	Digital Display with Memory Preset	46.99	
PAT-C	Casters	62.37	

Accessories for Height Adjustable Tables

OPTION	DESCRIPTION	PRICE
Modesty Panels	Perforated steel, laminate, Acrylite modesty panel and removable laminate for folding option	Visit SpecialT.net
Privacy Screens	Acrylite Privacy Screens, front or front and side (s)	
Grommets	Round or Rectangle	
Power & Data Management	Burele, EZ Power, Nacre, MhoB, Dean, Node, Ashley Duo Air, Villa, Cove, Interact G2	
Wire Management	J-Shape wire manager and table leg wire channel	
Table Connector	Quick Align	

HEIGHT ADJUSTABLE

Patriot Electric Bases

GS-28F-0015W



PART #	# OF STAGES	# OF COLUMNS	BASE SPREAD	LEG TYPE	RECOMMENDED TOP SIZE	CONFIGURE & PRICE
PAT-2STG-24T	2	2	22"	T-Leg	24" D x 48-84" W	703.61
PAT-2STG-30T	2	2	28"	T-Leg	30" D x 48-84" W	709.58
PAT-2STG-3COL-24T	2	3	22"	T-Leg	24" D x 60-72" W	1,082.11
PAT-2STG-3COL-30T	2	3	28"	T-Leg	30" D x 60-72" W	1,088.09
PAT-2STG-24C	2	2	22"	C-Leg	24" D x 48-84" W	703.61
PAT-2STG-30C	2	2	28"	C-Leg	30" D x 48-84" W	709.58
PAT-2STG-3COL-24C	2	3	22"	C-Leg	24" D x 60-72" W	1,082.11
PAT-2STG-3COL-30C	2	3	28"	C-Leg	30" D x 60-72" W	1,088.09
PAT-3STG-24T	3	2	22"	T-Leg	24" D x 48-84" W	762.56
PAT-3STG-30T	3	2	28"	T-Leg	30" D x 48-84" W	768.54
PAT-3STG-3COL-24T	3	3	22"	T-Leg	24" D x 60-72" W	1,147.47
PAT-3STG-3COL-30T	3	3	28"	T-Leg	30" D x 60-72" W	1,153.45
PAT-3STG-24C	3	2	22"	C-Leg	24" D x 48-84" W	762.56
PAT-3STG-30C	3	2	28"	C-Leg	30" D x 48-84" W	768.54
PAT-3STG-3COL-24C	3	3	22"	C-Leg	24" D x 60-72" W	1,147.47
PAT-3STG-3COL-30C	3	3	28"	C-Leg	30" D x 60-72" W	1,153.45

Specify -B for Black and -MS for Metallic Silver

HEIGHT ADJUSTABLE

Liberty Electric Tables

GS-28F-0015W

Rectangle | 2-Legs | Two Stage

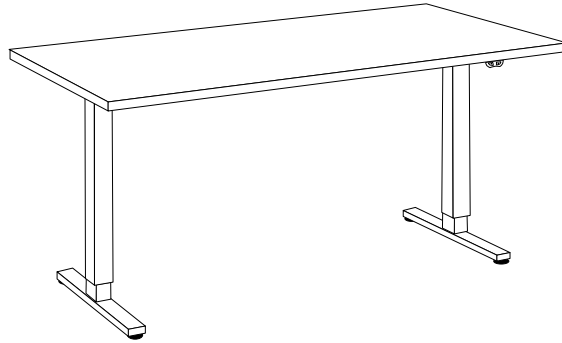

CONFIGURE & PRICE				
MODEL NUMBER	TFL	HPL	1-DAY	5-DAY
LIB-2448	643.80	703.61	-	-
LIB-2454	666.02	731.38	-	-
LIB-2460	672.85	741.20	-	-
LIB-2466	700.19	765.97	-	-
LIB-2472	700.19	772.38	-	-
LIB-3048	672.85	729.24	-	-
LIB-3054	700.19	762.98	-	-
LIB-3060	706.60	772.38	-	-
LIB-3066	737.35	803.57	-	-
LIB-3072	741.20	809.97	-	-

HEIGHT ADJUSTABLE

Liberty Electric Tables

GS-28F-0015W

2-Legs | Two Stage

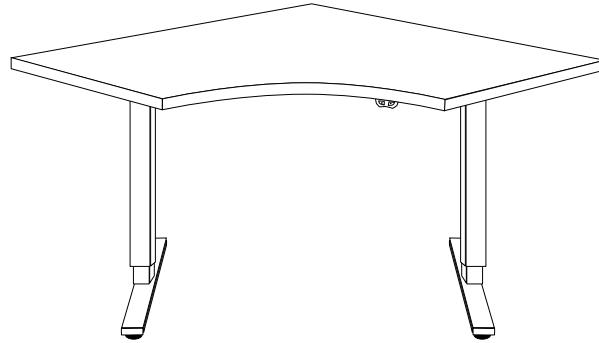

CONFIGURE & PRICE

SHAPE	MODEL NUMBER	TFL	HPL	1-DAY	5-DAY
Equal Corner	LIB-4224-EC	886.87	1,098.34	-	-
	LIB-4824-EC	901.40	1,121.83	-	-
Trapezoid	LIB-3060-TRA	781.78	975.30	-	-
	LIB-3072-TRA	835.61	991.11	-	-
Half-Round	LIB-3060-HRD	741.20	903.96	-	-
Crescent	LIB-2448-CRE	929.17	1,022.30	-	-
	LIB-2460-CRE	1,000.51	1,100.47	-	-
	LIB-3048-CRE	929.17	1,022.30	-	-
	LIB-3060-CRE	1,035.55	1,138.50	-	-

HEIGHT ADJUSTABLE

Liberty Electric Bases

GS-28F-0015W



PART NUMBER	# OF STAGES	# OF COLUMNS	BASE SPREAD	LEG TYPE	RECOMMENDED TOP SIZE	CONFIGURE & PRICE
LIBERTY-B	2	2	22.24"	T-LEG	24" D x 48-72" W	515.64
LIBERTY-MS	2	2	22.24"	T-LEG	24" D x 48-72" W	515.64
LIBERTY-W	2	2	22.24"	T-LEG	24" D x 48-72" W	515.64

STANDARD
TABLE FEATURES

STANDARD TABLE FEATURES

Special-T tables are manufactured from the highest quality products possible, meeting or exceeding ANSI/BIFMA standards.

HPL tabletops feature 1-1/8" thick 45 lb. density particle board core, high-pressure laminate, durable vinyl, wood or urethane edges, and .038 balanced backer sheet on less than 48" tables (.038 phenolic backer equal or greater than 48"). The finished top thickness is 1-1/4".

High-quality high-pressure Standard WilsonArt laminates are available for tops. Premium laminates are available for an additional charge.

TFL tabletops feature 1" low pressure, 45 lb density core, low-pressure laminate on both sides, and matching color vinyl edge.

A wide selection of table edges and edge colors are available. Edge options include durable vinyl, wood, and urethane edges.

Most tops are pre-drilled for easy installation. In addition, all 60" or longer tables sold without a continuous beam base include a steel table support to prevent tops from sagging.

Table legs feature high-quality tubular steel, stainless steel, cast aluminum, or cast iron. All tubular steel bases are available in 20 powder coat finishes at the standard price. Color matching is available; an upcharge may apply. Some bases are also available in polished chrome and stainless steel finishes. Leveling glides are standard for most tables. Tables legs ship knocked down and are easy to assemble.

The standard table height is 29".

Special-T demonstrates its dedication to the future of our environment in its products. Special-T products have passed stringent MAS Certificated Green™ Indoor Air Quality testing and comply with BIFMA X7.1, LEED, CDPH, and SHPS standards*.

*Wood edges are not MAS Certificated Green™

WARRANTY & RETURN POLICY



WARRANTY & RETURN

WARRANTY

January 1st, 2020

To expedite your warranty claims quickly and accurately, go to specialt.net/claims and fill out the Warranty/Freight claim form. All claims must reference the original Purchase Order number and Special-T Sales Order or Invoice number.

Tables. Complete tables and all components included therein are warranted for a period of 10 years from the date of original invoice against poor workmanship and manufacturing defects. We retain the right to replace or repair at our discretion any products or parts thereof which are found defective in materials or workmanship. This warranty becomes invalid for products engineered by client, whereas construction method, material specifications of final product assembly adversely affects materials and or workmanship. In no event, shall liability under this warranty exceed the original purchase price. This warranty becomes invalid if the product or part exhibits abuse, improper or unusual use, including striking tops against other objects. This warranty is invalid if the product is subject to caustic or abrasive cleaning agents or any alterations from its original condition. This warranty does not cover self edge tops and/or tables where table legs/bases are more than 60" apart and do not include steel top support. Our tables and table tops are not for outdoor use. Any damage related to the outdoor use is not covered under this warranty. This warranty does not apply to normal wear and tear or damage caused by accident, neglect, misuse or improper installation or operation. This warranty is expressly made in lieu of any and all other warranties expressed or implied.

Patriot Electric and Liberty Electric Height Adjustable Tables and Bases are warranted to the original purchaser for a period of 10 years from the date of delivery, under normal use for one, 8-hour shift per day against manufacturing defects. We will repair or replace, at our discretion, any products that we determine to be defective as a result of faulty workmanship. In no event shall our liability under this warranty exceed the original purchase price of the product determined to be defective. This warranty does not apply where the product has been abused, mishandled, or subjected to use other than that for which it was designed. For purposes of this warranty, normal wear to the product finish shall not be considered a defect.

Power & Data: All Power and Data components are warranted for a period of 1 year from date of original invoice, against poor workmanship and manufacturing defects. This warranty becomes invalid for products engineered by client, whereas construction method, material specifications of final product assembly adversely affects materials and or workmanship. In no event, shall liability under this warranty exceed the original purchase price. This warranty does not apply to normal wear and tear or damage caused by accident, neglect, misuse or improper installation or operation.

Labor Warranty is subject to written approval. It does not cover labor costs associated with concealed freight damage.

RETURN POLICY

The Return of any merchandise to the Special-T, LLC, warehouse must be authorized prior to shipment.

- All returns must be accompanied by a Return Merchandise Authorization Form (RMA). The RMA must be requested within thirty (30) days of the original invoice date. Please contact Customer Service at 888.705.0777, Monday to Friday, 8:00 am to 5:00 PM EST. Upon approval of the return, send the prepaid shipment to 11820 Wills Road, Suite 140, Alpharetta, GA 30009-0256.
- Tops - 30% restocking fee will apply if received in new condition
- Bases - 25% restocking fee will apply if received in new condition
- Products must be in new condition and in original carton
- The following items are non-returnable and non-refundable:
 - Custom table tops
 - Power and data units
 - Closeout tables and bases
 - Custom metal paint and Black Wrinkle finish
 - Metal bases with irreversible alterations

Cancellation Charges. There will be no cancellation charges prior to production. After production, the actual cost incurred will be assessed if the product cannot be sold after a six (6) month period.

Customer Service:

 888.705.0777

 customerservice@specialt.net

CONTACT INFORMATION

Warranty:

 888.705.0777

 warranty@specialt.net

COLOR OPTIONS

QUICK SHIP TOP COLOR OPTIONS

1-DAY QUICK SHIP TFL



CREMA
MAPLE



AGED
DRIFTWOOD

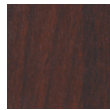

MAHOGANY*

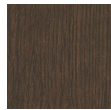

ESPRESSO



WHITE



LIGHT GRAY



CANVAS



CHINO

5-DAY QUICK SHIP HPL

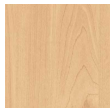

KENSINGTON
MAPLE

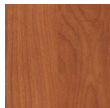

WILD
CHERRY

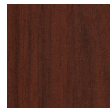

JUDICIAL
WALNUT*

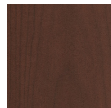

MOCHA*

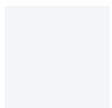

DESIGNER
WHITE

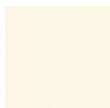

ANTIQUE
WHITE

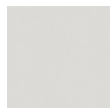

FASHION
GREY



SHADOW



BLACK

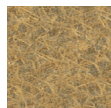

TUNGSTEN
EV

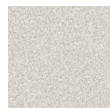

WHITE
NEBULA

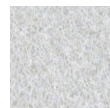

TITANIUM
EV

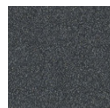

GRAPHITE
NEBULA

Standard laminate - no upcharge | Edges match the laminate color and pattern
Images are representative of the material and may not be an exact match.

*Premium colors - 10% upcharge | *While supplies last

LAMINATE COLORS

HPL WOODGRAIN



**WHITE
DRIFTWOOD***

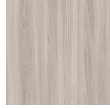

GREY ELM*



**KENSINGTON
MAPLE**

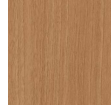

BRAZILWOOD

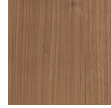

**RIVER
CHERRY**

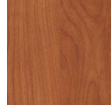

**WILD
CHERRY**

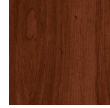

**WILLIAMS-
BURG
CHERRY***

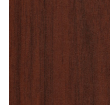

**JUDICIAL
WALNUT***

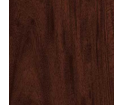

**EMPIRE
MAHOGANY***



COCOBALA*



MOCHA*

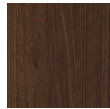

**COLOMBIAN
WALNUT***



**STUDIO
TEAK***



**SKYLINE
WALNUT***

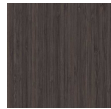

**ASIAN
NIGHT***

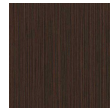

XANADU*



**EBONY
RECON**

HPL SOLID COLORS

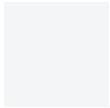

**DESIGNER
WHITE**



**ANTIQUE
WHITE**



**KHAKI
BROWN**



PEPPERDUST



SHADOW



**FASHION
GREY**



DOVE GREY



NORTH SEA



SLATE GREY



BLACK

HPL PATTERN DESIGN

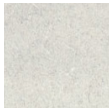

**WHITE
TIGRIS**

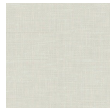

**CRISP
LINEN**

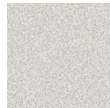

**WHITE
NEBULA**

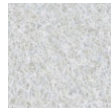

**TITANIUM
EV**



**DESERT
ZEPHYR**

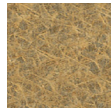

**TUNGSTEN
EV**

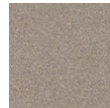

**CANYON
ZEPHYR**

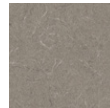

**EVENING
TIGRIS**



CARBON EV



**TWILIGHT
ZEPHYR**



**STEEL
MESH**

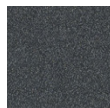

**GRAPHITE
NEBULA**

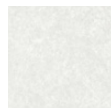

**GREY
PAMPAS**

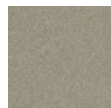

**LODEN
ZEPHYR**



**MISTED
ZEPHYR**



**NATURAL
TIGRIS**

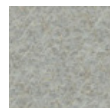

NICKEL



**PEWTER
BRUSH**

Select any WilsonArt or Formica laminates | Standard laminate - no upcharge | *Premium colors - 10% upcharge
Images are representative of the material and may not be an exact match.

EDGES & TOP OPTIONS

STANDARD VINYL EDGES



P3
3MM VINYL



P3R ROUNDED
CORNERS 3MM
VINYL



PK
KNIFE EDGE

HPL WOODGRAIN



WHITE
DRIFTWOOD*



GREY ELM*



KENSINGTON
MAPLE



BRAZIL-
WOOD



RIVER
CHERRY

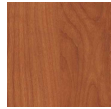

WILD
CHERRY

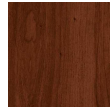

WILLIAMS-
BURG
CHERRY*



JUDICIAL
WALNUT*

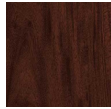

EMPIRE
MAHOGANY*



COCOBALA*

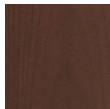

MOCHA*

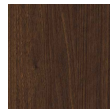

COLOMBIAN
WALNUT*

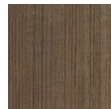

STUDIO
TEAK*



SKYLINE
WALNUT*

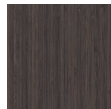

ASIAN
NIGHT*

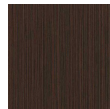

XANADU*



EBONY
RECON

HPL SOLID COLORS

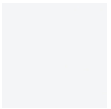

DESIGNER
WHITE



ANTIQUE
WHITE



KHAKI
BROWN



PEPPERDUST



SHADOW



FASHION
GREY



DOVE
GREY



NORTH SEA



SLATE GREY



BLACK

Select any WilsonArt or Formica laminates | Standard laminate - no upcharge | *Premium colors - 10% upcharge
All edges match the laminate color and pattern
Images are representative of the material and may not be an exact match.

EDGES & TOP OPTIONS

STANDARD VINYL EDGES



P3
3MM VINYL



P3R ROUNDED
CORNERS 3MM
VINYL



PK
KNIFE EDGE

HPL PATTERN DESIGN



WHITE
TIGRIS



CRISP
LINEN



WHITE
NEBULA



TITANIUM
EV



DESERT
ZEPHYR

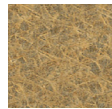

TUNGSTEN
EV



CANYON
ZEPHYR

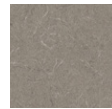

EVENING
TIGRIS

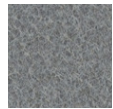

CARBON EV



TWILIGHT
ZEPHYR

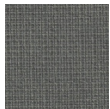

STEEL
MESH



GRAPHITE
NEBULA



GREY
PAMPAS /
FASHION
GREY**

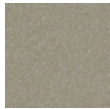

LODEN
ZEPHYR /
AMAZON**



MISTED
ZEPHYR
/DOVE
GREY**



NATURAL
TIGRIS /
SAND**

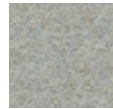

NICKEL /
AMAZON**

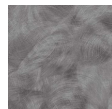

PEWTER
BRUSH /
GRAPHITE**

PK UNDER EDGE COLORS



PK

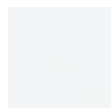

WHITE



BROWN

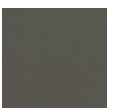

GREY



BLACK

Select any WilsonArt or Formica laminates | Standard laminate - no upcharge | *Premium colors - 10% upcharge

**Recommended edge color, not an exact laminate match

Images are representative of the material and may not be an exact match

METAL FINISH COLORS

QUICK SHIP STOCK COLORS



METALLIC
SILVER



BLACK

POWDER COAT COLORS

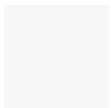

GLOSSY
WHITE



BEIGE



LIGHT TONE



SAND



INNERTONE
LIGHT



TAUPE



TAN



MEDIUM
TONE



HW
PLATINUM



SMOKE



GRAPHITE

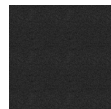

BLACK
WRINKLE

METALLIC POWDER COAT COLORS



METALLIC
SAND



GUN METAL

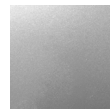

METALLIC
PLATINUM

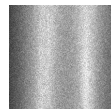

STEEL
SILVER

NON-POWDER COAT COLORS



STAINLESS
STEEL*

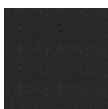

BLACK
WRINKLE

Metal finishes vary by base style | Additional charges may apply | *Not available in powder coat finishes
Images are representative of the material and may not be an exact match

PATRIOT METAL FINISH COLOR OPTIONS

PATRIOT QUICK SHIP STOCK COLOR

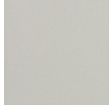

METALLIC SILVER
[MS]
METALLIC
SEMI-
GLOSS

PATRIOT METAL COLORS



BLACK
[B07]
MATTE

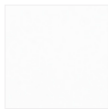

DESIGNER WHITE
[405]
MATTE



SOFT WHITE
[LU]
MATTE

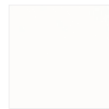

WHITE
[91]
MATTE



ANODIZED SILVER
[S09]



STARLIGHT SILVER
[S15]
METALLIC
SEMI-
GLOSS



WARM NEUTRAL GRAY
[WN]
MATTE



TAUPE METALLIC
[504]
METALLIC
SEMI-
GLOSS



MEDIUM TONE
[MT]
MATTE



METALLIC BRONZE
[EH]
METALLIC
SEMI-
GLOSS

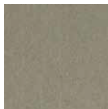

CLEAR
[CC05]
MATTE

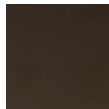

SATIN BRONZE
[SB]
MATTE



ANTHRACITE GRAY
[7016]
GLOSS



GRAPHITE
[G2]
MATTE



CARBON METALLIC
[514]
METALLIC
SEMI-
GLOSS



BUMPER BLACK
[B05]
GLOSS



COPPER TOP
[1023]
SEMI-
GLOSS



ORANGE
[OR01]
GLOSS



RED
[R02]
GLOSS



MOSS GREEN
[G01]
GLOSS



SIGNAL GREEN
[6032]
GLOSS



SERPO GREEN
[G03]
GLOSS



LIGHT GREEN
[6027]
GLOSS



SKY BLUE
[TR1J]
MATTE

Images are representative of the material and may not be an exact match.



TABLES, BASES & ACCESSORIES



11820 Wills Rd, Suite 140
Alpharetta, GA 30009
888.705.0777
www.SpecialT.net



Contract Holder
Contract # GS-28F-0014W / GS-28F-0015W