



CATALOG & PRICE LIST

TABLES BASES & ACCESSORIES

Effective August 15, 2022

special 

PRICING & FREIGHT NOTIFICATIONS

Pricing Disclaimer

Although the information in this Price List is presented in good faith and believed to be correct at the time of publication, Special-T has no liability for any errors or omissions. Also, please note that all prices are subject to change.

Special-T shall have the right to refuse or cancel any order placed for a product listed at the incorrect price. If an item's correct price is lower than our stated price, we will charge the lower amount and ship the item.

If an item's correct price is higher than our stated price, we will notify the price error for review and extend an opportunity to purchase the item at the correct price.

Freight Notifications

Minimum Freight Fee

FOB: Destination on table orders over 5,000 List.

195 freight fee on orders less than 5,000 List (Prepaid & Add) | Dock-to-Dock delivery.

Patriot Electric & Liberty Electric Bases Only

QTY: 1 - 3 55 each | 4-15 33 each | 16 - 50 27 each | 51 + 16 each

FOB: Alpharetta, GA; PPD & ADD | Dock-to-Dock delivery.

Shipments Outside Continental U.S.

Qualified Freight Prepaid orders with final destination outside Continental U.S. will ship to the Freight Forwarder or Port of Embarkation within the 48 contiguous states. Shipments from Freight Forwarder/Port of Embarkation will ship FOB: Origin to final destination.

Oversize Fee

All LTL shipments for pallets 8' and over

96"-108" - additional 250.00

109"-168" - additional 350.00

Per custom pallet



TABLE BASES & ACCESSORIES

CATALOG

For more than 20 years, Special-T has been manufacturing the industry's largest selection of tables and table accessories. Our customers include office furniture dealers, table manufacturers, and re-manufacturers. We provide products that are in demand, competitively priced, and exceed customer expectations of quality. We ship on time, ensure that orders arrive undamaged, and attribute our success to stellar customer service, high-quality products, and a comprehensive and easy-to-use online configurator at www.SpecialT.net

PURPOSE STATEMENT

Our goal is to develop long-term, mutually beneficial relationships using the highest level of values, ethics, and unique products.

Let us help you by:

- Putting profit back into your projects
- Solving problems with creative solutions
- Utilizing 'A' Grade tables and bases

PRODUCT IN STOCK READY TO SHIP | ENDLESS OPTIONS



SAME DAY SHIPPING

24-hour turn-around time | Over 300,000 bases in stock
You're never late on quick turn-around projects

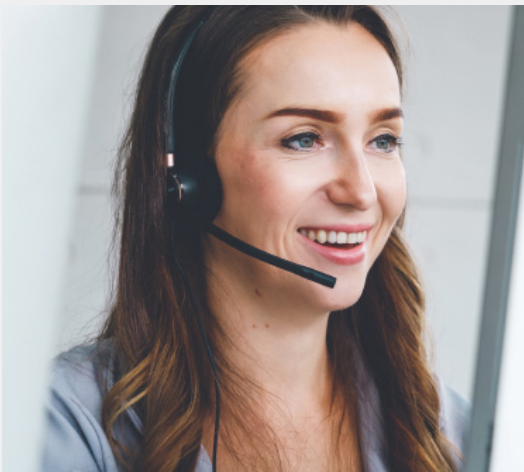

SPECIAL-T'S CUSTOMER SERVICE TEAM IS WAITING FOR YOUR CALL

- Personal attention
- Honesty, integrity
- We follow through
- We do what we promise

MORE CHOICES AND CUSTOMIZATION OPTIONS

- Highest quality powder-coating finishes
- 20 standard industry colors
- Stainless Steel & Cast Iron (on some models)
- Custom heights

CONFIGURE & PRICE ONLINE

Specify quotes and purchase in a matter of just minutes. Special-T's proprietary configurator software is one of the first to be introduced into the office furniture industry. An easy-to-use interface walks the user through the various stages of the table specifying process, allowing them to customize any of Special-T's products in a simple, quick, and error-free manner.

- Visit SpecialT.net
- Go to the "Bases and Accessories" tab
- Apply filters to select the desired base and options
- Call (888) 705-0777 with any questions

CONTRACTS WARRANTY/FREIGHT CLAIM REP LOCATOR RESELLER ACCOUNT CREATE ACCOUNT CONTACT US

special **T** COMPANY BY APPLICATION BY LEAD TIME **BASES & ACCESSORIES** RESOURCES Search

Products: Bases X Clear Filters Sort by: Ascending













 2CL Base Structure Bases	 2TL Base Structure Bases	 3 Column Round Base Stainless Steel	 4 Column X-Base Traditional
 4X Base Sienna Series	 4XL Base Structure Bases	 5 Column X-Base Traditional	 Arched AT-Leg Spring Clip Height Adjustable
 Bolt Down Base Stainless Steel	 Bolt Down Leg Posts	 Boomerang Dual Column Sienna Series	 Boomerang Single Center Sienna Series



TABLE BASES & ACCESSORIES

CATALOG & PRICE LIST | Effective August 15, 2022

STAINLESS STEEL

Stainless Steel Round Base	08
Stainless Steel Square Base	09
Stainless Steel Bolt Down Leg	10
Stainless Steel Post Leg	11

CAST IRON 2.0

Cast Iron 2.0 X and T Bases	12
Cast Iron 2.0 Round Base	14

CONTEMPORARY

Triangular Bases	16
------------------------	----

ARCHED

Arched Single Column T-Legs	17
Arched Dual Column T-Legs	19
Arched Single Column X-Legs	20

POST

Single Column Post Legs	21
1.5" Post Legs	22
Square Post Leg	23
Reveal Leg	24
Bolt Down Leg	25

TRADITIONAL

Bolted Single Column T-Legs	26
Welded Single Column T-Legs	29
EZ-Roll T-Legs	30
Dual Column T-Legs	31
Single Column C-Legs	33
Dual Column C-Legs	35
Dual Column H-Legs	37
Single Column X-Bases	39
Multi Column X-Bases	43
4 and 5 Column X-Bases	46

SIENNA SERIES

Sienna Round and Square Bases	47
Sienna X-Bases	49
Sienna Café Power Bases	51
Sienna Rectangle Base	53
Sienna T-Leg and C-Leg	54



TABLE BASES & ACCESSORIES

CATALOG & PRICE LIST | Effective August 15, 2022

STRUCTURE SERIES

Square End Base	56
Square H-Leg	57
Structure T-Leg and C-Leg	58
Structure Post Leg	59
Structure 4X-Base	60
Structure Cube	62

ADJUSTABLE HEIGHT

Spring Clip Height Adjustable Bases	63
Patriot Electric Height Adjustable Base	65
Liberty Electric Height Adjustable Base	67

FOLDING

Folding Legs	68
--------------------	----

FLIP & NEST

Kingston Flip Base	69
Convertible Base	71
Transform-2 Base	72

ACCESSORIES

Casters & Glides	73
Perforated Steel Modesty Panel	74
Frosted Acrylic Modesty Panel and Privacy Screen	75
Laminate Modesty Panel	76
Power & Data	77
Horizontal Wire Management	79
Vertical Wire Management	80
Table Connectors & Top Support	81
Monitor Arms	82

TOPS

1-Day Tops	83
------------------	----

FINISHES

Metal Finishes	84
Patriot Metal Finishes	85

Important Information	86
Warranty & Return Policy	88

STAINLESS STEEL ROUND BASE

The stainless steel Round Base is composed of 304-grade stainless steel. The high quality, beautiful finish, and style make this base perfect for office, restaurant, and hospitality applications.

■ FEATURES

- UNIT HEIGHT: 27.75"
40.75"
SSP720-RB is available only in 27.75" height
- MOUNTING PLATE: 13.75" x 13.75" square pressed steel
- COLUMN: 3" diameter; 1.5 mm thick; 304-grade stainless steel
- FLOOR PLATE: 17-23/32" x 17-23/32"
22-27/32" x 22-27/32"
28-23/64" x 28-23/64"
Cover plate is 1mm thick 304-grade Sunray Brushed Stainless Steel
- LEVELING GLIDES: 3/4" diameter plastic for leveling on uneven floors
- FINISH: Brushed Stainless Steel
- METHOD OF ASSEMBLY: Bolted construction
- PACKAGING: SSP450-RB are packed in 3 boxes
SSP720-RB are packaged in 5 boxes



SSP450-RB



SSP720-RB

■ STAINLESS STEEL ROUND BASE PRICING

PART #	UNIT HEIGHT	FLOOR PLATE DIAMETER	RECOMMENDED TOP SIZE	NET WEIGHT	LIST PRICE
SSP450-RB	27.75"	17-23/32"	≤ 32" Rd.	34 lbs	702
			≤ 28" Sq.		
SSP580-RB	27.75"	22-27/32"	≤ 40" Rd.	49 lbs	975
			≤ 36" Sq.		
SSP450-RB-42	40.75"	17-23/32"	≤ 30" Rd.	36 lbs	787
			≤ 24" Sq.		
SSP580-RB-42	40.75"	22-27/32"	≤ 36" Rd.	51 lbs	1,060
			≤ 32" Sq.		
SSP720-RB 3 columns	27.75"	28-23/64"	≤ 60" Rd.	91 lbs	927
			≤ 54" Sq.		

STAINLESS STEEL SQUARE BASE

Classic design meets a beautiful finish in this stainless steel table base; our Square Base features 304-grade stainless steel. It is perfect for architectural, office, restaurant, and hospitality applications.

FEATURES

UNIT HEIGHT:	27.75" 40.75"
MOUNTING PLATE:	13.75" x 13.75" square pressed steel
COLUMN:	3" diameter; 1.5 mm thick; 304-grade stainless steel
FLOOR PLATE:	17-23/32" x 17-23/32" 22-27/32" x 22-27/32" Cover plate is 1mm thick 304-grade linear Sunray Brushed Stainless Steel
LEVELING GLIDES:	3/4" diameter plastic for leveling on uneven floors
FINISH:	Brushed Stainless Steel
METHOD OF ASSEMBLY:	Bolted construction
PACKAGING:	Bases are packed in 3 boxes



SSP450-SB

STAINLESS STEEL SQUARE BASE PRICING

PART #	UNIT HEIGHT	FLOOR PLATE	RECOMMENDED TOP SIZE	NET WEIGHT	LIST PRICE
SSP450-SB	27.75"	17-23/32"	≤ 32" Rd.	39 lbs	739
			≤ 28" Sq.		
SSP580-SB	27.75"	22-27/32"	≤ 40" Rd.	59 lbs	1,008
			≤ 36" Sq.		
SSP450-SB-42	40.75"	17-23/32"	≤ 30" Rd.	41 lbs	824
			≤ 24" Sq.		
SSP580-SB-42	40.75"	22-27/32"	≤ 36" Rd.	61 lbs	1,093
			≤ 32" Sq.		

STAINLESS STEEL BOLT DOWN LEG

This stylish yet heavy-duty base provides form and function in bolt-down applications. It is perfect for office or hospitality settings. The base bolts to the floor with an 8" diameter floor plate and has a 3" column diameter.

■ FEATURES

- UNIT HEIGHT: 27.75"
40.75"
- MOUNTING PLATE: 13.75" x 13.75" square pressed steel
- COLUMN: 3" diameter; 1.5 mm thick; 304- grade stainless steel
- FLOOR PLATE: 8" diameter; cover plate is 1mm thick 304-grade Sunray Brushed Stainless Steel
- FINISH: Brushed Stainless Steel
- METHOD OF ASSEMBLY: Bolted construction
- PACKAGING: Bases are packed in 3 boxes



SSBD

■ STAINLESS STEEL BOLT DOWN LEG PRICING

PART #	UNIT HEIGHT	COLUMN DIAMETER	RECOMMENDED TOP SIZE	NET WEIGHT	LIST PRICE
SSBD	27.75"	3"	≤ 24" Rd.	16 lbs	347
			≤ 24" Sq.		
SSBD-42	40.75"	3"	≤ 24" Rd.	22 lbs	432
			≤ 24" Sq.		

STAINLESS STEEL POST LEG

Our Stainless Steel Post Leg is crafted from high-quality stainless steel.

FEATURES

UNIT HEIGHT:	27.75" 34.75" 40.75"
MOUNTING PLATE:	5" x 5", 2.5 mm die-stamped steel
COLUMN:	3" diameter; 1.5 mm thick; 304-grade stainless steel
LEVELING GLIDES:	3.25" x .75" black plastic with 1/2" of adjustment
FINISH:	Brushed Stainless Steel
METHOD OF ASSEMBLY:	Bolted construction
PACKAGING:	Bases are packaged 2 per box, priced individually



SS29-PL

STAINLESS STEEL POST LEG PRICING

PART #	UNIT HEIGHT	COLUMN DIAMETER	NET WEIGHT	LIST PRICE
SS29-PL	27.75"	3"	6 lbs	203
SS36-PL	34.75"	3"	7 lbs	244
SS42-PL	40.75"	3"	8 lbs	287

CAST IRON 2.0 X & T BASES

The Cast Iron 2.0 X and T Bases are fabricated from an 11 gauge tubular steel column and a heavy-duty cast iron floor base. Die-formed steel threaded rod and nut are used for assembly.



CI-2222X



CI-24T

CI-2222X-42-FR
With Foot Ring

■ FEATURES

UNIT HEIGHT:	27.75" 40.75"
WELDED	
MOUNTING PLATE:	9.5" x 9.5" x 5/32" die-stamped steel
COLUMN:	3" diameter
LEVELING GLIDES:	1-1/8" diameter plastic for leveling on uneven floors
FINISH:	Black Wrinkle and Fog Gray
METHOD OF ASSEMBLY:	Bolted construction
PACKAGING:	Foot and column are packaged in 2 boxes

■ OPTIONS

SELF LEVELING GLIDES:	Specify -SLG-M8 See page 73 for more information
FOOT RING:	Specify -FR 16" diameter, 12" high foot ring for 40.75" high bases

■ CAST IRON 2.0 X & T BASES PRICING

TYPE	PART #	UNIT HEIGHT	BASE SPREAD	RECOMMENDED TOP SIZE	NET WEIGHT	LIST PRICE
X-BASES	CI-2222X	27.75"	22/22"	≤ 30" Rd.	18 lbs	143
				≤ 24" Sq.		
	CI-2230X	27.75"	22/30"	≤ 36" Sq.	20 lbs	161
				≤ 36" Rd.		
	CI-3030X	27.75"	30/30"	≤ 42" Sq.	22 lbs	180
				≤ 42" Rd.		
X-BASES BAR HEIGHT	CI-2222X-42	40.75"	22/22"	≤ 24" Sq.	21 lbs	241
				≤ 24" Rd.		
	CI-2230X-42	40.75"	22/30"	≤ 36" Sq.	23 lbs	259
				≤ 36" Rd.		
	CI-3030X-42	40.75"	30/30"	≤ 36" Sq.	25 lbs	278
				≤ 36" Rd.		
T-BASES	CI-24T	27.75"	22"	24" - 30" x 36" - 72"	15 lbs	109
	CI-24T-42	40.75"	22"	24" - 30" x 36" - 72"	18 lbs	207
SELF- LEVELLING GLIDES	-SLG-M8	For X Base			-	+ 84
	-SLG-M8	For T Base			-	+ 42
FOOT- RING	-FR	12"			6 lbs	+ 104

CAST IRON 2.0 ROUND BASES

The Cast Iron 2.0 Round Base features a column made from 11 gauge tubular steel and a heavy-duty cast iron floor plate. Die-formed steel threaded rod and nut are used for assembly



CI-18R

CI-18R-42-FR3
With Foot Ring

■ FEATURES

UNIT HEIGHT:	27.75" 40.75"
WELDED	
MOUNTING PLATE:	9.5" x 9.5" x 5/32" die-stamped steel
LEVELING GLIDES:	1-1/8" diameter plastic for leveling on uneven floors
FINISH:	Black Wrinkle and Fog Gray
METHOD OF ASSEMBLY:	Bolted construction
PACKAGING:	Floor plate and column are packaged separately

■ OPTIONS

SELF LEVELING GLIDES:	Specify -SLG-M8. See page 73 for more information.
FOOT RING:	12" high, for 40.75" high bases Specify -FR-3 16" diameter for 3" column. Specify -FR-4 9.5" diameter for 4" column.

■ CAST IRON 2.0 ROUND BASES PRICING

TYPE	PART #	UNIT HEIGHT	FLOOR PLATE	COLUMN DIAMETER	RECOMMENDED TOP SIZE	NET WEIGHT	LIST PRICE
ROUND BASES	CI-18R	27.75"	18"	3"	≤ 30" Rd.	22 lbs	180
					≤ 24" Sq.		
	CI-24R	27.75"	24"	3"	≤ 42" Rd.	40 lbs	288
					≤ 36" Sq.		
	CI-30R	27.75"	30"	4"	≤ 54" Rd.	57 lbs	405
					≤ 48" Sq.		
ROUND BASES BAR HEIGHT	CI-18R-42	40.75"	18"	3"	≤ 26" Rd.	26 lbs	278
					≤ 22" Sq.		
	CI-24R-42	40.75"	24"	3"	≤ 36" Rd.	44 lbs	386
					≤ 32" Sq.		
	CI-30R-42	40.75"	30"	4"	≤ 48" Rd.	62 lbs	503
					≤ 42" Sq.		
SELF LEVELING GLIDES	-SLG-M8	Self-leveling glides - 18" Base				-	+ 84
	-SLG-M8	Self-leveling glides - 24" and 30" Bases				-	+ 105
FOOTRING	-FR-3 for 3" dia column	12"	-	16"	-	6 lbs	+ 104
	-FR-4 for 4" dia column	12"	-	19.5"	-	6 lbs	+ 104

TRIANGULAR BASES

Fabricated 14 gauge tubular steel with welded cross members.

FEATURES

UNIT HEIGHT:	27.75" 40.75"
WELDED MOUNTING PLATE:	(3) 4" x 4" x 7/32" triangle
FINISH:	Stock color is Black. See page 84 for more color options
PACKAGING:	Floor plate and column are packaged separately

OPTIONS

BALLAST:	One or two 4 lbs each. Ballasts can be mounted under a floor plate for more stability Specify -BALLAST-1 for 1 ballast Specify -BALLAST-2 for 2 ballasts
SELF LEVELING GLIDES:	Specify -SLG-2. See page 73 for more information

TRIANGULAR BASES PRICING

PART #	UNIT HEIGHT	COLUMN DIAMETER	BASE SPREAD	RECOMMENDED TOP SIZE	NET WEIGHT	LIST PRICE
TRI-8	27.75"	2"	10"	-	19 lbs	422
TRI-8-42	40.75"	2"	10"	-	26 lbs	513
TRI-8-18TRIP	27.75"	2"	18"	max 30" square	32 lbs	602
TRI-8-22TRIP	27.75"	2"	22"	max 36" square	38 lbs	667
TRI-8-26TRIP	27.75"	2"	26"	max 48" square	46 lbs	754
TRI8-18TRIP-42	40.75"	2"	18"	max 30" square	33 lbs	693
TRI8-22TRIP-42	40.75"	2"	22"	max 36" square	39 lbs	758
TRI8-26TRIP-42	40.75"	2"	26"	max 48" square	45 lbs	845
-SLG-2	Self-leveling Glides				-	+ 84
-BALLAST-1	1-four-pound ballast				4 lbs	+ 55
-BALLAST-2	2-four-pound ballasts				8 lbs	+ 112



TRI-8



TRI-8-18TRIP

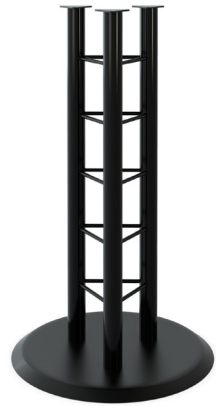

TRI-842-18TRIP

ARCHED SINGLE COLUMN T-LEGS

Our Arched T-Legs feature the highest quality 14 gauge tubular steel; the column and arched foot are 2" in diameter. All threaded inserts are welded for maximum strength.



1ATL-24



1ATL-24-AH



1ATL-24-AH-SC

■ FEATURES

UNIT HEIGHT:	27.75" 40.75"
WELDED MOUNTING PLATE:	5"x 8"x 7/32"
LEVELING GLIDES:	1-3/8" diameter plastic in steel threaded inserts
FINISH:	Stock color is Black. See page 84 for more color options
PACKAGING:	Bases are packed 2 per box, priced individually

■ OPTIONS

ADJUSTABLE HEIGHT:	Adjusts in 1" increments from 24.75" to 34.75". See page 63 for more information.
SELF LEVELING GLIDES:	Specify -SLG
CUSTOM HEIGHT:	Specify -CUSTHT1 for height between 5" - 27.75" Specify -CUSTHT2 for height between 27.75" - 40.75"
CASTERS:	Specify -SC. 3" locking skate casters, each 112 lbs capacity

■ ARCHED SINGLE COLUMN T-LEGS PRICING

	PART #	UNIT HEIGHT	COLUMN DIA	BASE SPREAD	MOUNTING PLATE	RECOMMENDED TOP WIDTH	NET WEIGHT	LIST PRICE (EACH)	
FIXED HEIGHT	1ATL-18	27.75"	2"	16"	5"x 8"x 7/32"	18" - 22"	7 lbs	167	
	1ATL-24	27.75"	2"	22"	5"x 8"x 7/32"	24" - 28"	7 lbs	171	
	1ATL-30	27.75"	2"	26"	5"x 8"x 7/32"	28" - 30"	8 lbs	174	
	1ATL-24-SC	27.75"	2"	22"	5"x 8"x 7/32"	24" - 28"	7 lbs	235	
	1ATL-30-SC	27.75"	2"	26"	5"x 8"x 7/32"	28" - 30"	8 lbs	238	
	1ATL-18-42	40.75"	2"	16"	5"x 8"x 7/32"	18" - 22"	9 lbs	230	
	1ATL-24-42	40.75"	2"	22"	5"x 8"x 7/32"	24" - 28"	9 lbs	234	
	1ATL-30-42	40.75"	2"	26"	5"x 8"x 7/32"	28" - 30"	10 lbs	237	
ADJUSTABLE HEIGHT	1ATL-18-AH	27.75"	2"	16"	5"x 8"x 7/32"	18" - 22"	6 lbs	276	
	1ATL-24-AH	27.75"	2"	22"	5"x 8"x 7/32"	24" - 28"	9 lbs	280	
	1ATL-30-AH	27.75"	2"	26"	5"x 8"x 7/32"	28" - 30"	10 lbs	283	
CUSTOM HEIGHT	-CUSTHT1	For height between 5" - 27.75"						7 lbs	+ 68
	-CUSTHT2	For height between 27.75" - 40.75"						8-10 lbs	+ 131
SLG	-SLG	Self-leveling Glides						-	+ 42
SC	-SC	Locking Skate Casters						-	+ 64

ARCHED DUAL COLUMN T-LEGS

This base is fabricated from the highest quality 14 gauge tubular steel. The columns and arched foot are 2" in diameter. All threaded inserts are welded for maximum strength.



2ATL-24

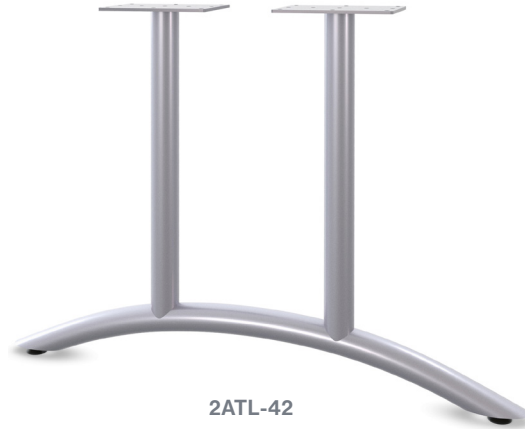

2ATL-42

FEATURES

- UNIT HEIGHT: 27.75"
- LEVELING GLIDES: 1-3/8" diameter plastic with steel threaded inserts
- FINISH: Stock color is Black
See page 84 for more color options
- PACKAGING: Bases are packed 2 per box, priced individually

OPTIONS

- CUSTOM HEIGHT: Specify -CUSTHT1 for height between 5" - 27.75"

ARCHED DUAL COLUMN T-LEGS PRICING

PART #	UNIT HEIGHT	COLUMN DIAMETER	BASE SPREAD	MOUNTING PLATE SIZE	RECOMMENDED TOP DEPTH	NET WEIGHT	LIST PRICE (EACH)
2ATL-24	27.75"	2"	22"	5" x 12"	24" - 28"	12 lbs	240
2ATL-30	27.75"	2"	26"	5" x 12"	30" - 36"	13 lbs	245
2ATL-42	27.75"	2"	36"	(2) 5" x 8" welded	42" - 46"	14 lbs	255
2ATL-48	27.75"	2"	42"	(2) 5" x 8" welded	46" - 48"	14 lbs	260
-CUSTHT1	For height between 5" - 27.75"						+ 136

ARCHED SINGLE COLUMN X-BASE

X-Bases are fabricated from the highest quality 14 gauge tubular steel. The column is 3", and the arched feet are 2" in diameter. The mounting plate and all threaded inserts are welded for maximum strength.

FEATURES

- UNIT HEIGHT: 27.75" and 40.75"
- LEVELING GLIDES: 1-3/8" diameter plastic with steel threaded inserts
- FINISH: Stock color is Black. See page 84 for more color options
- PACKAGING: Bases and feet are packaged in one box

OPTIONS

- CUSTOM HEIGHT: Specify -CUSTHT1 for height between 5" - 27.75"
Specify -CUSTHT2 for height between 27.75" - 40.75"
- SELF LEVELING GLIDES: Specify -SLG
- CASTERS: Specify -SC . 3" Locking skate casters, each 112 lbs. capacity



1AXL-30



1AXL-30-42

ARCHED SINGLE COLUMN X-BASE PRICING

PART #	UNIT HEIGHT	COLUMN DIAMETER	BASE SPREAD	MOUNTING PLATE SIZE	RECOMMENDED TOP DEPTH	NET WEIGHT	LIST PRICE (EACH)	
1AXL-30	27.75"	3"	26" x 26"	8" x 8" x 7/32" welded	24" - 28"	14 lbs	306	
1AXL-36	27.75"	3"	32" x 32"	8" x 8" x 7/32" welded	30" - 36"	16 lbs	321	
1AXL-42	27.75"	3"	38" x 38"	8" x 8" x 7/32" welded	42" - 46"	19 lbs	344	
1AXL-30-42	40.75"	3"	26" x 26"	8" x 8" x 7/32" welded	24" - 28"	14 lbs	403	
1AXL-36-42	40.75"	3"	32" x 32"	8" x 8" x 7/32" welded	30" - 36"	16 lbs	418	
1AXL-42-42	40.75"	3"	38" x 38"	8" x 8" x 7/32" welded	42" - 46"	19 lbs	441	
-CUSTHT1	For height between 5" - 27.75"							+ 68
-CUSTHT2	For height between 27.75" - 40.75"							+ 165
-SLG	Self-leveling Glides							+ 84
-SC	Skate Casters							+ 128

SINGLE COLUMN POST LEGS

Single Column Post Legs are fabricated with 14 gauge steel. Threaded inserts for levelers or casters are welded for maximum strength.

FEATURES

UNIT HEIGHT:	27.75" 40.75"
WELDED MOUNTING PLATE:	4" x 4" x 7/32" or 6" x 6" x 7/32" welded
LEVELING GLIDES:	1-3/8" diameter plastic with steel threaded inserts; PL-27-4 has a 4" metal glide
CASTERS:	PL-27-2-C and PL-27-C have a 2" dual-wheel locking caster, 112 lbs capacity
FINISH:	Stock color is Black, PL-27-2 is also stocked in Metallic Silver. See page 84 for more color options
PACKAGING:	Bases are packaged 2 per box PL-27-2 and PL-27-2-C are packaged 4 per box PL-27-342 and PL-27-442 are packaged one per box Priced individually

OPTIONS

CUSTOM HEIGHT:	Specify -CUSTHT1 for height between 5" - 27.75" Specify -CUSTHT2 for height between 27.75" - 40.75"
----------------	--

SINGLE COLUMN POST LEGS PRICING

PART #	UNIT HEIGHT	COLUMN DIAMETER	MOUNTING PLATE SIZE	NET WEIGHT	LIST PRICE (EACH)
PL-27-2	27.75"	2"	4" x 4"	4 lbs	76
PL-27-2-MS Metallic Silver	27.75"	2"	4" x 4"	4 lbs	76
PL-27-2-C with casters	27.75"	2"	4" x 4"	4 lbs	95
PL-27-2FM folding leg	27.75"	2"	5" x 8"	7 lbs	234
PL-27-3	27.75"	3"	6" x 6"	6 lbs	112
PL-27-342	40.75"	3"	6" x 6"	10 lbs	175
PL-27-4	27.75"	4"	6" x 6"	8 lbs	152
PL-27-442	40.75"	4"	6" x 6"	12 lbs	215
-CUSTHT1	For height between 5" - 27.75"				+ 68
-CUSTHT2	For height between 27.75" - 40.75"				+ 131



PL-27-2FM



PL-27-4

1.5" POST LEGS

1.5" diameter tubular columns are fabricated with 14 gauge steel.



■ FEATURES

UNIT HEIGHT:	27.75"
WELDED MOUNTING PLATE:	4" x 4" x 7/32"
BELL GLIDE:	2-3/8" diameter nylon glide in 2.5" high steel extender
CASTERS:	3" locking skate wheel caster with black core; 112 lbs capacity
ADJUSTABLE HEIGHT:	Adjustable range from 24.75" to 34.75" Adjusts in 1" increments
FINISH:	Stock color is Black. See page 84 for more color options
PACKAGING:	Bases are packaged 4 per box, priced individually

■ 1.5" POST LEGS PRICING

PART #	UNIT HEIGHT	COLUMN DIAMETER	MOUNTING PLATE SIZE	NET WEIGHT	LIST PRICE (EA)
SPYL with bell glide	27.75"	1.5"	4" x 4"	4 lbs	110
SPYL-SC with caster	27.75"	1.5"	4" x 4"	4 lbs	110
SPYL-AH spring clip adjustable height	27.75"	1.5"	4" x 4"	5 lbs	142

SQUARE POST LEG

Square post legs are fabricated with 14 gauge square steel threaded inserts for levelers. Post mounts flush with the table corner.

FEATURES

UNIT HEIGHT:	27.75" 40.75"
WELDED	
MOUNTING PLATE:	5" x 5" x 7/32"
LEVELING GLIDES:	2-3/8" diameter plastic with steel threaded inserts
CASTERS:	SQ-RH-C comes with a 2.5" dual-wheel locking caster, 112 lbs capacity
FINISH:	SQ-RH is stocked in Black and Metallic Silver See page 84 for more color options
PACKAGING:	Bases are packaged 4 per box, priced individually

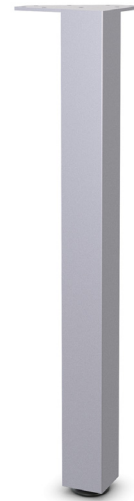

SQ-RH

OPTIONS

CUSTOM HEIGHT:	Specify -CUSTHT1 for height between 5" - 27.75" Specify -CUSTHT2 for height between 27.75" - 40.75"
----------------	--

SQUARE POST LEG PRICING

PART #	UNIT HEIGHT	COLUMN DIAMETER	NET WEIGHT	LIST PRICE (EACH)
SQ-RH	27.75"	2-3/8"	6 lbs	121
SQ-RH-MS Metallic Silver	27.75"	2-3/8"	6 lbs	121
SQ-RH-C with Caster	27.75"	2-3/8"	6 lbs	140
SQ-RH-42 Bar Height	40.75"	2-3/8"	9 lbs	184
-CUSTHT1	For height between 5" - 27.75"			+ 68
-CUSTHT2	For height between 27.75" - 40.75"			+ 131

REVEAL LEG

The Reveal legs are fabricated with 14 gauge 2" diameter tubular steel, 45° angle support is welded to a 6" x 6" mounting plate for maximum strength.

■ FEATURES

- UNIT HEIGHT: 27.75"
- WELDED
- MOUNTING PLATE: 6" x 6" x 7/32" steel
- LEVELING GLIDES: 1-3/8" diameter plastic with steel threaded inserts
- FINISH: Stock color is Black. See page 84 for more color options
- PACKAGING: Bases are packaged 2 per box, priced individually

■ OPTIONS

- CUSTOM HEIGHT: Specify -CUSTHT1 for height between 5" - 27.75"



RL

■ REVEAL LEG PRICING

PART #	UNIT HEIGHT	COLUMN DIAMETER	MOUNTING PLATE SIZE	NET WEIGHT	LIST PRICE (EACH)
RL	27.75"	2"	6" x 6"	6 lbs	170
-CUSTHT1	For height between 5" - 27.75"				+ 68

BOLT DOWN LEG

This stylish yet heavy-duty base provides form and function in bolt-down applications. It is perfect for educational or hospitality settings—the base bolts to the floor with a 6" diameter plate and 3" column diameter.

FEATURES

UNIT HEIGHT:	27.75" 34.75" 40.75"
WELDED MOUNTING PLATE:	10" x 10"
COLUMN:	3" diameter
FLOOR PLATE:	6" diameter cover
FINISH:	Stock color is Black. See page 84 for more color options
METHOD OF ASSEMBLY:	Bolted construction
PACKAGING:	Bases are packaged in 2 boxes



OPTIONS

CUSTOM HEIGHT:	Specify -CUSTHT1 for height between 5" - 27.75" Specify -CUSTHT2 for height between 27.75" - 40.75"
----------------	--

BOLT DOWN LEG PRICING

PART #	UNIT HEIGHT	COLUMN DIAMETER	NET WEIGHT	LIST PRICE (EACH)
BD-29	27.75"	3"	13 lbs	170
BD-36 Counter Height	34.75"	3"	14 lbs	233
BD-42 Bar Height	40.75"	3"	15 lbs	233
-CUSTHT1	5" - 27.75"	3"	up to 13 lbs	+ 68
-CUSTHT2	27.75" - 40.75"	3"	up to 15 lbs	+ 131

SINGLE COLUMN T-LEG

Fabricated 14 gauge steel with steel end caps and threaded inserts for levelers or casters featuring a bolted construction.



TL-24



TL-22-C

■ FEATURES

UNIT HEIGHT:	27.75" 34.75" 40.75"
WELDED	
MOUNTING PLATE:	5" x 8" x 7/32" steel
LEVELING GLIDES:	1-3/8" diameter plastic with steel threaded inserts
FINISH:	Stock color is Black See page 84 for more color options
PACKAGING:	Bases are packaged 2 per box, priced individually

■ OPTIONS

CUSTOM HEIGHT:	Specify -CUSTHT1 for height between 5" - 27.75" Specify -CUSTHT2 for height between 27.75" - 40.75"
BAR HEIGHT:	Specify -42
COUNTER HEIGHT:	Specify -36
ADJUSTABLE HEIGHT:	Specify -AH. See page 63 for more information
CASTERS:	Specify -C. 2" dual-wheel locking caster, 112 lbs capacity
SELF-LEVELING GLIDES:	Specify -SLG-M8. See page 73 for more information
FOLDING:	Specify -GFM. See page 68 for more information

■ SINGLE COLUMN T-LEG PRICING

	PART #	UNIT HEIGHT	COLUMN DIAMETER	BASE SPREAD	MOUNTING PLATE SIZE	RECOMMENDED TOP DEPTH	NET WEIGHT	LIST PRICE (EACH)
STANDARD	TL-18	27.75"	2"	16"	5" x 8"	24" - 28"	7.50 lbs	179
	TL-20	27.75"	2"	18"	5" x 8"	26" - 32"	7.75 lbs	179
	TL-22	27.75"	2"	20"	5" x 8"	28" - 24"	8.00 lbs	182
	TL-24	27.75"	2"	22"	5" x 8"	30" - 36"	8.50 lbs	182
	TL-30	27.75"	2"	26"	5" x 8"	42" - 46"	9.00 lbs	186
CASTERS	TL-18-C	27.75"	2"	16"	5" x 8"	24" - 28"	7.50 lbs	217
	TL-20-C	27.75"	2"	18"	5" x 8"	26" - 32"	7.75 lbs	217
	TL-22-C	27.75"	2"	20"	5" x 8"	28" - 24"	8.00 lbs	220
	TL-24-C	27.75"	2"	22"	5" x 8"	30" - 36"	8.50 lbs	220
	TL-30-C	27.75"	2"	26"	5" x 8"	42" - 46"	9.00 lbs	224
COUNTER HEIGHT	TL-18-36	34.75"	2"	16"	5" x 8"	24" - 28"	8.50 lbs	242
	TL-20-36	34.75"	2"	18"	5" x 8"	26" - 32"	7.75 lbs	242
	TL-22-36	34.75"	2"	20"	5" x 8"	28" - 24"	8.50 lbs	245
	TL-24-36	34.75"	2"	22"	5" x 8"	30" - 36"	9.00 lbs	245
	TL-30-36	34.75"	2"	26"	5" x 8"	42" - 46"	10.00 lbs	249
BAR HEIGHT	TL-18-42	40.75"	2"	16"	5" x 8"	24" - 28"	9.50 lbs	242
	TL-20-42	40.75"	2"	18"	5" x 8"	26" - 32"	9.75 lbs	242
	TL-22-42	40.75"	2"	20"	5" x 8"	28" - 24"	10.00 lbs	245
	TL-24-42	40.75"	2"	22"	5" x 8"	30" - 36"	10.50 lbs	245
	TL-30-42	40.75"	2"	26"	5" x 8"	42" - 46"	11.00 lbs	249

■ SINGLE COLUMN T-LEG PRICING

	PART #	UNIT HEIGHT	COLUMN DIAMETER	BASE SPREAD	MOUNTING PLATE SIZE	RECOMMENDED TOP DEPTH	NET WEIGHT	LIST PRICE (EACH)
ADJUSTABLE HEIGHT	TL-18-AH	24.75 - 34.75"	2"	16"	5" x 8"	24" - 28"	10.50 lbs	288
	TL-20-AH	24.75 - 34.75"	2"	18"	5" x 8"	26" - 32"	10.75 lbs	288
	TL-22-AH	24.75 - 34.75"	2"	20"	5" x 8"	28" - 24"	11.00 lbs	291
	TL-24-AH	24.75 - 34.75"	2"	22"	5" x 8"	30" - 36"	11.50 lbs	291
	TL-30-AH	24.75 - 34.75"	2"	26"	5" x 8"	42" - 46"	12.00 lbs	295
AH 34.75 - 44.75	TL-18-42AH	34.75 - 44.75"	2"	16"	5" x 8"	24" - 28"	9.50 lbs	388
	TL-24-42AH	34.75 - 44.75"	2"	18"	5" x 8"	30" - 36"	10.50 lbs	391
	TL-30-42AH	34.75 - 44.75"	2"	20"	5" x 8"	42" - 46"	11.00 lbs	395
FOLDING	TL-18-GFM	27.75"	2"	16"	5" x 8"	24" - 28"	10.50 lbs	427
	TL-20-GFM	27.75"	2"	18"	5" x 8"	26" - 32"	10.75 lbs	427
	TL-22-GFM	27.75"	2"	20"	5" x 8"	28" - 24"	11.00 lbs	430
	TL-24-GFM	27.75"	2"	22"	5" x 8"	30" - 36"	11.50 lbs	430
	TL-30-GFM	27.75"	2"	26"	5" x 8"	42" - 46"	12.00 lbs	434
OPTIONS	-CUSTHT1	For height between 5" - 27.75"						+ 68
	-CUSTHT2	For height between 27.75" - 40.75"						+ 131
	-C	Casters						+ 38
	-SLG-M8	Self-leveling Glides						+ 42

WELDED SINGLE COLUMN T-LEG

Fabricated 14 gauge steel with steel endcaps and threaded inserts for levelers or casters. Featuring welded construction.

FEATURES

UNIT HEIGHT:	27.75"
WELDED MOUNTING PLATE:	5" x 8" x 7/32" steel
LEVELING GLIDES:	1-3/8" diameter plastic with steel threaded inserts
FINISH:	Stock color is Black. See page 84 for more color options
PACKAGING:	Bases are packaged 2 per box, priced individually



TL-24W

OPTIONS

Self-leveling Glides:	Specify -SLG-8 See page 73 for more information
-----------------------	--

WELDED SINGLE COLUMN T-LEG PRICING

PART #	UNIT HEIGHT	COLUMN DIAMETER	BASE SPREAD	RECOMMENDED TOP DEPTH	NET WEIGHT	LIST PRICE (EACH)
TL-18W	27.75"	2"	16"	18" - 20"	7 lbs	179
TL-24W	27.75"	2"	22"	24" - 28"	8 lbs	182
TL-30W	27.75"	2"	26"	28" - 30"	9.5 lbs	186
TL-36W	27.75"	2"	30"	34" - 36"	10 lbs	256
-SLG-M8	Self-leveling Glides					+ 42

EZ-ROLL T-LEG

T-Leg with concealed EZ-Roll wheels is stationary or can be mobile when tilted. Fabricated 14 gauge 2" diameter columns with steel endcaps and hid EZ-Roll wheels.

■ FEATURES

- UNIT HEIGHT: 27.75"
- WELDED
- MOUNTING PLATE: 5" x 8" x 7/32"
- EZ-ROLL WHEELS: 1.5" diameter built-in wheels
- FINISH: Stock color is Black. See page 84 for more color options
- PACKAGING: Bases are packed 2 per box, priced individually



TL30-EZ

■ OPTIONS

- CUSTOM HEIGHT: Specify -CUSTHT1 for height between 5" - 27.75"



Built-in EZ-Roll wheel

■ EZ-ROLL T-LEG PRICING

PART #	COLUMN DIAMETER	BASE SPREAD	RECOMMENDED TOP DEPTH	NET WEIGHT	LIST PRICE (EACH)
TL-18-EZR	2"	16"	18" - 22"	7 lbs	223
TL-24-EZR	2"	22"	24" - 26"	8 lbs	226
TL-30-EZR	2"	26"	28" - 30"	9 lbs	228
-CUSTHT1	For height between 5" - 27.75"				+ 68

DUAL COLUMN T-LEGS

Fabricated 14 gauge steel with steel endcaps and threaded inserts for levelers or casters.



2TL-30



2TL-30-C

■ FEATURES

UNIT HEIGHT:	27.75" 40.75"
MOUNTING PLATE:	7/32" steel
LEVELING GLIDES:	1-3/8" diameter plastic with steel threaded inserts
FINISH:	Stock color is Black. See page 84 for more color options
PACKAGING:	2TL-24, 2TL-30, 2TL-36, 2TL-42, and 2TL-48 bases are packed 2 per box, priced individually 2TL-60 bases are packed 1 per box, priced individually

■ OPTIONS

CUSTOM HEIGHT:	Specify -CUSTHT1 for height between 5" - 27.75" Specify -CUSTHT2 for height between 27.75" - 40.75"
BAR HEIGHT:	Specify -42
ADJUSTABLE HEIGHT:	Specify -AH. See page 63 for more information
CASTERS:	Specify -C. 2" dual-wheel locking caster
SELF LEVELING GLIDES:	Specify -SLG-M8. See page 73 for more information

■ DUAL COLUMN T-LEGS PRICING

	PART #	UNIT HEIGHT	COLUMN DIAMETER	BASE SPREAD	MOUNTING PLATE SIZE	RECOMMENDED TOP DEPTH	NET WEIGHT	LIST PRICE (EACH)
STANDARD	2TL-24	27.75"	2"	22"	5" x 11" welded	24" - 28"	13 lbs	245
	2TL-30	27.75"	2"	26"	5" x 11" welded	30" - 36"	14 lbs	248
	2TL-42	27.75"	2"	36"	6" x 16"	42" - 46"	17 lbs	269
	2TL-48	27.75"	2"	42"	6" x 16"	48" - 52"	17 lbs	281
	2TL-60	27.75"	2-3/8"	42"	(2) 6" x 6"	52" - 60"	18 lbs	365
CASTERS	2TL-24-C	27.75"	2"	22"	5" x 11" welded	24" - 28"	13 lbs	283
	2TL-30-C	27.75"	2"	26"	5" x 11" welded	30" - 36"	14 lbs	286
	2TL-42-C	27.75"	2"	36"	6" x 16"	42" - 46"	17 lbs	307
	2TL-48-C	27.75"	2"	42"	6" x 16"	48" - 52"	17 lbs	319
BAR HEIGHT	2TL-24-42	40.75"	2"	22"	5" x 11" welded	24" - 28"	18 lbs	371
	2TL-30-42	40.75"	2"	26"	5" x 11" welded	30" - 36"	19 lbs	374
	2TL-42-42	40.75"	2"	36"	6" x 16"	42" - 46"	22 lbs	395
	2TL-48-42	40.75"	2"	42"	6" x 16"	48" - 52"	22 lbs	407
ADJUSTABLE HEIGHT	2TL-24-AH	24.75" - 34.75"	2"	22"	(2) 5" x 8"	24" - 28"	19 lbs	463
	2TL-30-AH	24.75" - 34.75"	2"	26"	(2) 5" x 8"	30" - 36"	20 lbs	466
	2TL-42-AH	24.75" - 34.75"	2"	36"	(2) 5" x 8"	42" - 46"	23 lbs	487
	2TL-48-AH	24.75" - 34.75"	2"	42"	(2) 5" x 8"	48" - 52"	23 lbs	499
CUSTOM HEIGHT	-CUSTHT1	For height between 5" - 27.75"						+ 136
	-CUSTHT2	For height between 27.75" - 40.75"						+ 262
SLG	-SLG-M8	Self-leveling Glides						+ 42

SINGLE COLUMN C-LEGS

Fabricated 14 gauge steel with steel endcaps and threaded inserts for levelers or casters.



CL-24



CL-24-C

■ FEATURES

UNIT HEIGHT:	27.75" 34.75" 40.75"
MOUNTING PLATE:	5" x 8" 7/32" steel
LEVELING GLIDES:	1-3/8" diameter plastic with steel threaded inserts
FINISH:	Stock color is Black. See page 84 for more color options
PACKAGING:	Bases are packed 2 per box, priced individually

■ OPTIONS

CUSTOM HEIGHT:	Specify -CUSTHT1 for height between 5" - 27.75" Specify -CUSTHT2 for height between 27.75" - 40.75"
BAR HEIGHT:	Specify -42
COUNTER HEIGHT:	Specify -36
ADJUSTABLE HEIGHT:	Specify -AH. See page 63 for more information
CASTERS:	Specify -C. 2" dual-wheel locking caster, 112 lbs capacity
SELF LEVELING GLIDES:	Specify -SLG-M8. See page 73 for more information
FOLDING:	Specify -GFM. See page 68 for more information

■ SINGLE COLUMN C-LEGS PRICING

	PART #	UNIT HEIGHT	COLUMN DIAMETER	BASE SPREAD	MOUNTING PLATE SIZE	RECOMMENDED TOP DEPTH	NET WEIGHT	LIST PRICE (EACH)
STANDARD	CL-18	27.75"	2"	22"	5" x 8"	24" - 28"	7.5 lbs	179
	CL-24	27.75"	2"	26"	5" x 8"	30" - 36"	8.5 lbs	182
	CL-30	27.75"	2"	36"	5" x 8"	42" - 46"	9.0 lbs	186
CASTERS	CL-18-C	27.75"	2"	22"	5" x 8"	24" - 28"	7.5 lbs	217
	CL-24-C	27.75"	2"	26"	5" x 8"	30" - 36"	8.5 lbs	220
	CL-30-C	27.75"	2"	36"	5" x 8"	42" - 46"	9.0 lbs	224
COUNTER HEIGHT	CL-18-36	34.75"	2"	22"	5" x 8"	24" - 28"	8.5 lbs	242
	CL-24-36	34.75"	2"	26"	5" x 8"	30" - 36"	9.0 lbs	245
	CL-30-36	34.75"	2"	36"	5" x 8"	42" - 46"	10.0 lbs	249
BAR HEIGHT	CL-18-42	40.75"	2"	22"	5" x 8"	24" - 28"	9.5 lbs	242
	CL-24-42	40.75"	2"	26"	5" x 8"	30" - 36"	10.5 lbs	245
	CL-30-42	40.75"	2"	36"	5" x 8"	42" - 46"	11.0 lbs	249
ADJUSTABLE HEIGHT	CL-18-AH	24.75" - 34.75"	2"	22"	5" x 8"	24" - 28"	10.5 lbs	288
	CL-24-AH	24.75" - 34.75"	2"	26"	5" x 8"	30" - 36"	11.5 lbs	291
	CL-30-AH	24.75" - 34.75"	2"	36"	5" x 8"	42" - 46"	12.0 lbs	295
FOLDING	CL-18-GFM	27.75"	2"	22"	5" x 8"	24" - 28"	10.0 lbs	427
	CL-24-GFM	27.75"	2"	26"	5" x 8"	30" - 36"	11.0 lbs	430
	CL-30-GFM	27.75"	2"	36"	5" x 8"	42" - 46"	11.5 lbs	434
CUSTOM HEIGHT	-CUSTHT1	For height between 5" - 27.75"						+ 68
	-CUSTHT2	For height between 27.75" - 40.75"						+ 131
SLG	-SLG-M8	Self-leveling Glides						+ 42

DUAL COLUMN C-LEGS

Fabricated 14 gauge steel with steel endcaps and threaded inserts for levelers or casters.



2CL-30



2CL-30-C

■ FEATURES

UNIT HEIGHT:	27.75" 34.75 40.75"
MOUNTING PLATE:	5" x 11" 7/32" steel
LEVELING GLIDES:	1-3/8" diameter plastic with steel threaded inserts
FINISH:	Stock color is Black See page 84 for more color options
PACKAGING:	Bases are packed 2 per box, priced individually

■ OPTIONS

CUSTOM HEIGHT:	Specify -CUSTHT1 for height between 5" - 27.75" Specify -CUSTHT2 for height between 27.75" - 40.75"
BAR HEIGHT:	Specify -42
ADJUSTABLE HEIGHT:	Specify -AH. See page 63 for more information
CASTERS:	Specify -C. 2" dual-wheel locking caster, 112 lbs capacity
SELF LEVELING GLIDES:	Specify -SLG.-M8. See page 73 for information

■ DUAL COLUMN C-LEG PRICING

	PART #	UNIT HEIGHT	COLUMN DIAMETER	BASE SPREAD	MOUNTING PLATE SIZE	RECOMMENDED TOP DEPTH	NET WEIGHT	LIST PRICE (EACH)
STANDARD	2CL-24	27.75"	2"	22"	5" x 11" welded	24"- 28"	13 lbs	245
	2CL-30	27.75"	2"	26"	5" x 11" welded	28"- 30"	14 lbs	248
CASTERS	2CL-24-C	27.75"	2"	22"	(2) 5" x 8"	24"- 28"	13 lbs	283
	2CL-30-C	27.75"	2"	26"	(2) 5" x 8"	28"- 30"	14 lbs	286
BAR HEIGHT	2CL-24-42	40.75"	2"	22"	(2) 5" x 8"	24"- 28"	18 lbs	371
	2CL-30-42	40.75"	2"	26"	(2) 5" x 8"	28"- 30"	19 lbs	374
ADJUSTABLE HEIGHT	2CL-24-AH	24.75" - 34.75"	2"	22"	(2) 5" x 8"	24"- 28"	19 lbs	463
	2CL-30-AH	24.75" - 34.75"	2"	26"	(2) 5" x 8"	28"- 30"	20 lbs	466
CUSTOM HEIGHT	-CUSTHT1	For height between 5" - 27.75"						+ 136
	-CUSTHT2	For height between 27.75" - 40.75"						+ 262
SLG	-SLG-M8	Self-leveling Glides						+ 42

DUAL COLUMN H-LEGS

Fabricated 14 gauge steel with threaded inserts for levelers or casters.



■ FEATURES

UNIT HEIGHT:	27.75" 34.75 40.75"
MOUNTING PLATE:	(2) 6" x 6" x 7/32" steel
LEVELING GLIDES:	1-3/8" diameter plastic with steel threaded inserts
FINISH:	Stock color is Black See page 84 for more color options
PACKAGING:	Bases are packed 2 per box, priced individually

■ OPTIONS

CUSTOM HEIGHT:	Specify -CUSTHT1 for height between 5" - 27.75" Specify -CUSTHT2 for height between 27.75" - 40.75"
COUNTER HEIGHT:	Specify -36
BAR HEIGHT:	Specify -42
SELF LEVELING GLIDES:	Specify -SLG-M8. See page 73 for information

■ DUAL COLUMN H-LEGS PRICING

	PART #	UNIT HEIGHT	COLUMN DIAMETER	BASE SPREAD	RECOMMENDED TOP DEPTH	NET WEIGHT	LIST PRICE (EACH)	
STANDARD	HL-24	27.75"	2"	16.5"	24" - 28"	12 lbs	179	
	HL-30	27.75"	2"	22.5"	30" - 40"	13 lbs	201	
	HL-330	27.75"	3"	23.5"	30" - 40"	18 lbs	234	
	HL-342	27.75"	3"	30"	42" - 48"	18 lbs	272	
CASTERS	HL-24-C	27.75"	2"	16.5"	24" - 28"	12 lbs	217	
	HL-30-C	27.75"	2"	22.5"	30" - 40"	13 lbs	239	
COUNTER HEIGHT	HL-2436	34.75"	2"	16.5"	24" - 28"	13 lbs	305	
	HL-3036	34.75"	2"	22.5"	30" - 40"	15 lbs	327	
BAR HEIGHT	HL-2442	40.75"	2"	16.5"	24" - 28"	15 lbs	305	
	HL-3042	40.75"	2"	22.5"	30" - 40"	16 lbs	327	
CUSTOM HEIGHT	-CUSTHT1	For height between 5" - 27.75"						+ 136
	-CUSTHT2	For height between 27.75" - 40.75"						+ 262
SLG	-SLG-M8	Self-leveling Glides						+ 42

SINGLE COLUMN X-BASES

Fabricated 14 gauge steel with steel endcaps and threaded inserts for levelers or casters.
Bolted construction



XL-36



XL-24QF
Quick-Flip Mechanism



XL-42-36
Rectangular X Base

■ FEATURES

UNIT HEIGHT:	27.75"
LEVELING GLIDES:	1-3/8" diameter plastic with steel threaded inserts
FINISH:	Stock color is Black. See page 84 for more color options
PACKAGING:	Bases are packaged in 2 boxes

■ OPTIONS

CUSTOM HEIGHT:	Specify -CUSTHT1 for height between 5" - 27.75" Specify -CUSTHT2 for height between 27.75" - 40.75"
BAR HEIGHT:	Specify -42
CASTERS:	Specify -C. 2" dual-wheel locking caster, 112 lbs capacity
SELF LEVELING GLIDES:	Specify -SLG-M8. See page 73 for information
FLIP TOP:	Specify -QF Quick-flip mechanism flips top by pulling on the release handle. Top locks automatically when returned to a horizontal position

■ SINGLE COLUMN X-BASES PRICING

	PART #	COLUMN DIAMETER	BASE SPREAD	MOUNTING PLATE SIZE	RECOMMENDED TOP SIZE		NET WEIGHT	LIST PRICE	
					ROUND	SQUARE			
FIXED TOP STANDARD HEIGHT	XL-24	3"	20" x 20"	8" x 8"	20" - 24" Rd.	20" - 22" Sq.	15 lbs	272	
	XL-30	3"	26" x 26"	8" x 8"	26" - 36" Rd.	26" - 30" Sq.	17 lbs	281	
	XL-36	3"	32" x 32"	8" x 8"	32" - 42" Rd.	32" - 36" Sq.	19 lbs	288	
	XL-42	3"	36" x 36"	8" x 8"	36" - 48" Rd.	36" - 42" Sq.	21 lbs	296	
	XL-48	3"	42" x 42"	8" x 8"	42" - 52" Rd.	42" - 48" Sq.	23 lbs	306	
						RECTANGULAR			
	XL-30/24	3"	26" x 20"	8" x 8"	30" x 24"		13 lbs	281	
	XL-36/24	3"	32" x 20"	8" x 8"	36" x 24"		13 lbs	288	
	XL-36/30	3"	32" x 26"	8" x 8"	36" x 30"		15 lbs	288	
	XL-42/24	3"	36" x 20"	8" x 8"	42" x 24"		13 lbs	296	
	XL-42/30	3"	36" x 26"	8" x 8"	42" x 30"		15 lbs	296	
	XL-42/36	3"	36" x 32"	8" x 8"	42" x 36"		15 lbs	296	
	XL-48/24	3"	42" x 20"	8" x 8"	48" x 24"		13 lbs	306	
	XL-48/30	3"	42" x 26"	8" x 8"	48" x 30"		15 lbs	306	
XL-48/36	3"	42" x 30"	8" x 8"	48" x 36"		15 lbs	306		
XL-48/42	3"	42" x 36"	8" x 8"	48" x 42"		16 lbs	306		
					ROUND				
FLIP TOP	XL-24-QF flip top	3"	20" x 20"	8" x 8"	20" - 24" Rd.		20 lbs	512	
	XL-30-QF flip top	3"	26" x 26"	8" x 8"	26" - 30" Rd.		25 lbs	521	
	XL-36-QF flip top	3"	32" x 32"	8" x 8"	32" - 36" Rd.		29 lbs	528	
CUSTOM HEIGHT	-CUSTHT1	For height between 5" - 27.75"						+ 68	
	-CUSTHT2	For height between 27.75" - 40.75"						+ 131	
SLG	-SLG-M8	Self-leveling Glides						+ 84	

■ SINGLE COLUMN X-BASES PRICING

	PART #	COLUMN DIAMETER	BASE SPREAD	MOUNTING PLATE SIZE	RECOMMENDED TOP SIZE		NET WEIGHT	LIST PRICE	
					ROUND	SQUARE			
FIXED TOP STANDARD HEIGHT WITH CASTERS	XL-24-C	3"	20" x 20"	8" x 8"	20" - 24" Rd.	20" - 22" Sq.	15 lbs	348	
	XL-30-C	3"	26" x 26"	8" x 8"	26" - 36" Rd.	26" - 30" Sq.	17 lbs	357	
	XL-36-C	3"	32" x 32"	8" x 8"	32" - 42" Rd.	32" - 36" Sq.	19 lbs	364	
	XL-42-C	3"	36" x 36"	8" x 8"	36" - 48" Rd.	36" - 42" Sq.	21 lbs	372	
	XL-48-C	3"	42" x 42"	8" x 8"	42" - 52" Rd.	42" - 48" Sq.	23 lbs	382	
						RECTANGULAR			
	XL-30/24-C	3"	26" x 20"	8" x 8"	30" x 24"		13 lbs	357	
	XL-36/24-C	3"	32" x 20"	8" x 8"	36" x 24"		13 lbs	364	
	XL-36/30-C	3"	32" x 26"	8" x 8"	36" x 30"		15 lbs	364	
	XL-42/24-C	3"	36" x 20"	8" x 8"	42" x 24"		13 lbs	372	
	XL-42/30-C	3"	36" x 26"	8" x 8"	42" x 30"		15 lbs	372	
	XL-42/36-C	3"	36" x 32"	8" x 8"	42" x 36"		15 lbs	372	
	XL-48/24-C	3"	42" x 20"	8" x 8"	48" x 24"		13 lbs	382	
	XL-48/30-C	3"	42" x 26"	8" x 8"	48" x 30"		15 lbs	382	
XL-48/36-C	3"	42" x 30"	8" x 8"	48" x 36"		15 lbs	382		
XL-48/42-C	3"	42" x 36"	8" x 8"	48" x 42"		16 lbs	382		
					ROUND				
FLIP TOP WITH CASTERS	XL-24-QFC flip top	3"	20" x 20"	8" x 8"	20" - 24" Rd.		20 lbs	588	
	XL-30-QFC flip top	3"	26" x 26"	8" x 8"	26" - 30" Rd.		25 lbs	597	
	XL-36-QFC flip top	3"	32" x 32"	8" x 8"	32" - 36" Rd.		29 lbs	604	

■ SINGLE COLUMN X-BASES PRICING

PART #	COLUMN DIAMETER	BASE SPREAD	MOUNTING PLATE SIZE	RECOMMENDED TOP SIZE		NET WEIGHT	LIST PRICE
				ROUND	SQUARE		
XL-24-42	3"	20" x 20"	8" x 8"	20" - 24" Rd.	20" - 22" Sq.	15 lbs	335
XL-30-42	3"	26" x 26"	8" x 8"	26" - 36" Rd.	26" - 30" Sq.	17 lbs	344
XL-36-42	3"	32" x 32"	8" x 8"	32" - 42" Rd.	32" - 36" Sq.	19 lbs	351
XL-42-42	3"	36" x 36"	8" x 8"	36" - 48" Rd.	36" - 42" Sq.	21 lbs	359
XL-48-42	3"	42" x 42"	8" x 8"	42" - 52" Rd.	42" - 48" Sq.	23 lbs	369
				RECTANGULAR			
XL-30/24-42	3"	26" x 20"	8" x 8"	30" x 24"		13 lbs	344
XL-36/24-42	3"	32" x 20"	8" x 8"	36" x 24"		13 lbs	351
XL-36/30-42	3"	32" x 26"	8" x 8"	36" x 30"		15 lbs	351
XL-42/24-42	3"	36" x 20"	8" x 8"	42" x 24"		13 lbs	359
XL-42/30-42	3"	36" x 26"	8" x 8"	42" x 30"		15 lbs	359
XL-42/36-42	3"	36" x 32"	8" x 8"	42" x 36"		15 lbs	359
XL-48/24-42	3"	42" x 20"	8" x 8"	48" x 24"		13 lbs	369
XL-48/30-42	3"	42" x 26"	8" x 8"	48" x 30"		15 lbs	369
XL-48/36-42	3"	42" x 30"	8" x 8"	48" x 36"		15 lbs	369
XL-48/42-42	3"	42" x 36"	8" x 8"	48" x 42"		16 lbs	369

FIXED TOP BAR HEIGHT

MULTI COLUMN X-BASES

Fabricated 11 gauge steel columns and 14 gauge feet with threaded inserts for levelers or casters. Bolted construction.



2XL-3672



3XL-4896



4XL-48144

■ FEATURES

UNIT HEIGHT:	27.75"
MOUNTING PLATE:	8" x 8" x 7/32" steel
LEVELING GLIDES:	1-3/8" diameter plastic with steel threaded inserts
FINISH:	Stock color is Black. See page 84 for more color options
PACKAGING:	2XL ships in 2 boxes, 3XL ships in 3 boxes, 4XL ships in 4 boxes

■ OPTIONS

BAR HEIGHT:	Specify -42. Available for 2XL, 3XL, 4XL
CASTERS:	Specify -C . 2" dual-wheel locking caster, 112 lbs capacity
SELF LEVELING GLIDES:	Specify -SLG-M8. See page 73 for information

■ DUAL COLUMN X-BASES PRICING



	PART #	COLUMN DIAMETER	BASE SPREAD	RECOMMENDED TOP SIZE	NET WEIGHT	LIST PRICE
STANDARD	2XL-2460	3"	53" x 20"	24" x 60"	31 lbs	576
	2XL-2466	3"	59" x 20"	24" x 66"	32 lbs	576
	2XL-2472	3"	62" x 20"	24" x 72"	33 lbs	576
	2XL-3060	3"	53" x 26"	30" x 60"	37 lbs	576
	2XL-3066	3"	59" x 26"	30" x 66"	34 lbs	576
	2XL-3072	3"	62" x 26"	30" x 72"	35 lbs	576
	2XL-3672	3"	68" x 32"	36" x 72"	38 lbs	576
	2XL-3684	3"	78" x 32"	36" x 84"	40 lbs	576
	2XL-4284	3"	78" x 36"	42" x 84"	42 lbs	576
CASTERS	2XL-2460-C	3"	53" x 20"	24" x 60"	31 lbs	690
	2XL-2466-C	3"	59" x 20"	24" x 66"	32 lbs	690
	2XL-2472-C	3"	62" x 20"	24" x 72"	33 lbs	690
	2XL-3060-C	3"	53" x 26"	30" x 60"	37 lbs	690
	2XL-3066-C	3"	59" x 26"	30" x 66"	34 lbs	672
	2XL-3072-C	3"	62" x 26"	30" x 72"	35 lbs	672
	2XL-3672-C	3"	68" x 32"	36" x 72"	38 lbs	672
	2XL-3684-C	3"	78" x 32"	36" x 84"	40 lbs	672
	2XL-4284-C	3"	78" x 36"	42" x 84"	42 lbs	672
OPTIONS	-42	Bar Height 42"				126
	-SLG-M8	Self-leveling Glides				126

■ TRIPLE COLUMN X-BASES PRICING



PART #	COLUMN DIAMETER	BASE SPREAD	RECOMMENDED TOP SIZE	NET WEIGHT	LIST PRICE
3XL-4296	3"	90" x 36"	42" x 96"	57 lbs	899
3XL-42108	3"	102" x 36"	42" x 108"	54 lbs	921
3XL-4896	3"	90" x 42"	48" x 96"	60 lbs	946
3XL-48108	3"	102" x 42"	48" x 108"	62 lbs	949
3XL-48120	3"	114" x 42"	48" x 120"	65 lbs	975
-42	Bar Height 42"				189
-SLG-M8	Self-leveling Glides				168

■ QUADRUPLE COLUMN X-BASES PRICING



PART #	COLUMN DIAMETER	BASE SPREAD	RECOMMENDED TOP SIZE	NET WEIGHT	LIST PRICE
4XL-48144	3"	131" x 42"	48" x 144"	81 lbs	1,253
-42	Bar Height 42"				252
-SLG-M8	Self-leveling Glides				210

4 & 5 COLUMN X-BASES

Fabricated 14 gauge steel with steel endcaps and threaded inserts for levelers or casters.
Bolted construction featuring 4-columns or 5-columns.



4XL-38



4XL-38-C



5XL-48

FEATURES

- UNIT HEIGHT: 27.75"
- MOUNTING PLATE: 4 column base - (4) 4" x 4" x 7/32" steel | 5 column base - (5) 10" x 10" cast spider
- LEVELING GLIDES: 1-3/8" diameter plastic with steel threaded inserts
- FINISH: Stock color is Black. See page 84 for more color options
- PACKAGING: 4 column bases are packaged in 1 box | 5 column bases are packaged in 2 boxes

OPTIONS

- BAR HEIGHT: Specify -42. 4 column base only.
- CASTERS: Specify -C. 2" dual-wheel locking caster, 112 lbs capacity
- SELF-LEVELING
- GLIDES: Specify -SLG-M8. See page 73 for information

4 COLUMN X-BASES | 5 COLUMN X-BASES | PRICING

PART #	UNIT HEIGHT	COLUMN DIAMETER	BASE SPREAD	MOUNTING PLATE SIZE	RECOMMENDED TOP SIZE	NET WEIGHT	LIST PRICE
4XL-38	27.75"	2"	38" x 38"	(4) 4" x 4"	42" - 60" Rd.	34 lbs	554
					42" - 60" Sq.		
4XL-38-C	27.75"	2"	38" x 38"	(4) 4" x 4"	42" - 60" Rd.	34 lbs	630
					42" - 60" Sq.		
4XL-38-42	40.75"	2"	38" x 38"	(4) 4" x 4"	42" - 60" Rd.	44 lbs	806
					42" - 60" Sq.		
5XL-48	27.75"	2"	48" x 48"	(5) 10" x 10"	60" - 84" Rd.	37 lbs	603
					60" - 72" Sq.		
5XL-48-C	27.75"	2"	48" x 48"	(5) 10" x 10"	60" - 84" Rd.	37 lbs	679
					60" - 72" Sq.		
-SLG-M8	Self-leveling Glides						+ 84

SIENNA ROUND & SQUARE BASES

Sienna bases provide a modern look for offices, breakrooms, and training rooms. These bases feature a 4" column with 3/8" thick laser-cut solid steel and flush-mounted adjustable glides.



C4-22FPR

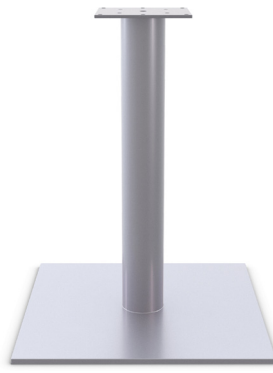

C442-2222FPS



Foot Ring Option

■ FEATURES

UNIT HEIGHT:	27.75" 40.75"
WELDED	
MOUNTING PLATE:	8" x 8" x 7/32" steel
COLUMN:	4" diameter
LEVELING GLIDES:	3/4" diameter plastic for leveling on uneven floors
FINISH:	Stock colors are Black (-BL) and Metallic Silver (-MS) See page 84 for more color options
PACKAGING:	Bases are packed in 2 boxes; priced individually Footring is packaged 1 per box

■ OPTIONS

CUSTOM HEIGHT:	Specify -CUSTHT1 for height between 5" - 27.75" Specify -CUSTHT2 for height between 27.75" - 40.75"
Self-leveling Glides:	Specify -SLG-M8 Round bases require 5 Self-leveling Glides Square bases require 4 Self-leveling Glides See page 73 for information
FOOT RING:	Specify -FR-4.12" high

■ SIENNA ROUND & SQUARE BASES PRICING

PLATE TYPE	PART #	COLUMN DIAMETER	UNIT HEIGHT	PLATE SIZE	RECOMMENDED TOP DEPTH	NET WEIGHT	LIST PRICE (EACH)
ROUND	C4-18FPR	4"	27.75"	18" D	24"- 30"	38 lbs	509
	C4-22FPR	4"	27.75"	22" D"	30"- 36"	51 lbs	612
	C4-26FPR	4"	27.75"	26" D"	36"- 48"	67 lbs	735
	C442-18FPR bar height	4"	40.75"	18" D	24"- 30"	41 lbs	572
	C442-22FPR bar height	4"	40.75"	22" D"	30"- 36"	54 lbs	675
	C442-26FPR bar height	4"	40.75"	26" D"	36"- 48"	70 lbs	798
	C442-18FPR-FR with foot ring	4"	40.75"	18" D	24"- 30"	47 lbs	676
	C442-22FPR-FR with foot ring	4"	40.75"	22" D"	30"- 36"	60 lbs	779
	C442-26FPR-FR with foot ring	4"	40.75"	26" D"	36"- 48"	76 lbs	902
	-SLG-M8	Self-leveling Glides					

SQUARE	C4-1818FPS	4"	27.75"	18" x 18"	24"- 30"	46 lbs	509
	C4-2222FPS	4"	27.75"	22" x 22"	30"- 36"	65 lbs	612
	C4-2626FPS	4"	27.75"	26" x 26"	36"- 48"	86 lbs	735
	C442-1818FPS bar height	4"	40.75"	18" x 18"	24"- 30"	49 lbs	572
	C442-2222FPS bar height	4"	40.75"	22" x 22"	30"- 36"	68 lbs	675
	C442-2626FPS bar height	4"	40.75"	26" x 26"	36"- 48"	89 lbs	798
	C442-1818FPS-FR with foot ring	4"	40.75"	18" x 18"	24"- 30"	55 lbs	676
	C442-2222FPS-FR with foot ring	4"	40.75"	22" x 22"	30"- 36"	74 lbs	779
	C442-2626FPS-FR with foot ring	4"	40.75"	26" x 26"	36"- 48"	95 lbs	902
	-SLG-M8	Self-leveling Glides					

OPTIONS	FR-4		12"			6 lbs	+ 104	
	-CUSTHT1	For height between 5" - 27.75"						+ 68
	-CUSTHT2	For height between 27.75" - 40.75"						+ 131

SIENNA X BASES

Sienna X bases were designed for breakroom or conference room applications. The floor plate is heavy-duty 3/8" thick laser-cut solid steel.



C4-2626FPP



4C3-4848FPP



4C342-4848FPP

■ FEATURES

UNIT HEIGHT:	27.75" 40.75"
WELDED MOUNTING PLATE:	8" x 8" x 7/32" steel
COLUMN:	Single column - 4" diameter 4 columns - 3" diameter
LEVELING GLIDES:	2-3/8" diameter plastic with steel threaded inserts
FINISH:	Stock colors are Black (-BL) and Metallic Silver (-MS) See page 84 for more color options
PACKAGING:	Single column X base is packaged in 2 boxes 4 column X base is packaged in 5 boxes

■ OPTIONS

CUSTOM HEIGHT:	Specify -CUSTHT1 for height between 5" - 27.75" Specify -CUSTHT2 for height between 27.75" - 40.75"
BAR HEIGHT:	Specify -42
CASTERS:	Specify -SC . 3" locking skate wheel caster with 112 lbs capacity
SELF LEVELING GLIDES:	Specify -SLG-M8. See page 73 for information

■ SIENNA X BASES PRICING

COLUMNS	HEIGHT	PART #	COLUMN DIAMETER	UNIT HEIGHT	BASE SPREAD	RECOMMENDED TOP SIZE	NET WEIGHT	LIST PRICE (EACH)	
1	STANDARD	C4-2626FPP	4"	27.75"	26" x 26"	30" - 36" DIA	26 lbs	582	
		C4-3232FPP	4"	27.75"	32" x 32"	36" - 42" DIA	32 lbs	660	
		C4-3636FPP	4"	27.75"	36" x 36"	42" - 48" DIA	39 lbs	767	
	BAR	C442-2626FPP	4"	40.75"	26" x 26"	30" - 36" DIA	46 lbs	645	
		C442-3232FPP	4"	40.75"	32" x 32"	36" - 42" DIA	49 lbs	723	
		C442-3636FPP	4"	40.75"	36" x 36"	42" - 48" DIA	65 lbs	830	
	CUSTOM	-CUSTHT1	For height between 5" - 27.75"						+ 68
		-CUSTHT2	For height between 27.75" - 40.75"						+ 131

4	STANDARD	4C3-4848FPP	3"	27.75"	48" x 48"	54" - 72" RD	90 lbs	1,056	
	BAR	4C342-4848FPP	3"	40.75"	48" x 48"	54" - 72" DIA	100 lbs	1,308	
	CUSTOM	-CUSTHT1	For height between 5" - 27.75"						+ 272
		-CUSTHT2	For height between 27.75" - 40.75"						+ 524

OPTIONS	CASTERS	-SC	Skate Casters					+ 128
	GLIDES	-SLG-M8	Self-leveling Glides					+ 84

SIENNA CAFÉ POWER BASES



Sienna Café Power low-profile bases are an authentic meeting solution conveniently allowing to charge via power or USB; a power cord runs through the base column for a clean look. Power is sold separately.

The effortless elegance of Node's clean, flush-mount design is sure to complement a wide range of aesthetics, stylish plated or powder coat finish belies a robust, die-cast construction. Refined but versatile, Node offers a range of power, data, and USB configurations.



Node Receptacle



CP-22FPR-3



CP-2626FPP

FEATURES

UNIT HEIGHT:	27.75"
WELDED MOUNTING PLATE:	12.5" x 7" x 2.5" steel
COLUMN:	3" and 4" diameter
LEVELING GLIDES:	2 3/8" diameter plastic with steel threaded inserts
FINISH:	Stock: Black (-BL) & Metallic Silver (-MS). See page 84 for more color options
PACKAGING:	Bases are packed in 4 boxes
ELECTRICAL:	15 Amp power per outlet and 2 Amp per USB port, 120" power cord Black or Silver

BASE OPTIONS

BAR HEIGHT:	Specify -42
SELF LEVELING GLIDES:	Specify -SLG-M8 Round bases use 5 X bases use 4 See page 73 for information
FOOT RING:	Specify -FR-4. 12" high

ELECTRICAL OPTIONS

- 2-Power
- 1-Power / 1 USB port

■ SIENNA CAFÉ POWER BASES PRICING

	PART #	COLUMN DIAMETER	UNIT HEIGHT	PLATE/ BASE SPREAD	RECOMMENDED TOP SIZE	NET WEIGHT	LIST PRICE (EACH)
ROUND BASE	CP-22FPR-3	3"	27.75"	22" D	30"- 36"	51 lbs	660
	CP-26FPR-4	4"	27.75"	26" D	36"- 48"	67 lbs	808
	CP-22FPR-3-42 bar height	3"	40.75"	22" D	30"- 36"	60 lbs	723
	CP-26FPR-4-42 bar height	4"	40.75"	26" D	36"- 48"	76 lbs	871
	-SLG-M8	Self-leveling Glides					

X BASE	CP-2626FPP	3"	27.75"	26" x 26"	30"- 36"	26 lbs	658
	CP-3232FPP	3"	27.75"	32" x 32"	36"- 42"	32 lbs	732
	CP-3636FPP	4"	27.75"	36" x 36"	42"- 48"	39 lbs	869
	CP-2626FPP-42 bar height	3"	40.75"	26" x 26"	30"- 36"	46 lbs	721
	CP-3232FPP-42 bar height	3"	40.75"	32" x 32"	36"- 42"	49 lbs	795
	CP-3636FPP-42 bar height	4"	40.75"	36" x 36"	42"- 48"	65 lbs	932
	-SLG-M8	Self-leveling Glides					

OPTIONS	-FR-4		12"			6 lbs	+ 104
---------	-------	--	-----	--	--	-------	-------

	PART #	COLOR	CONFIGURATION	LIST PRICE (EACH)
ELECTRICAL	NODE-1PU-120-MS	Metallic Silver	1 Power / USB Duplex	+ 355
	NODE-1PU-120-B	Black	1 Power / 1 USB Duplex	+ 355
	NODE-2PU-120-MS	Metallic Silver	2 Power	+ 258
	NODE-2PU-120-B	Black	2 Power	+ 258

SIENNA RECTANGLE BASE

Sienna Rectangle bases were designed for conference tables and collaboration applications. This base features two 3" diameter columns and a heavy-duty solid steel rectangular floor plate 3/8" thick.

FEATURES

UNIT HEIGHT:	27.75" 40.75
WELDED MOUNTING PLATE:	6" x 6" x 7/32" steel
COLUMN:	3" diameter
LEVELING GLIDES:	3/4" diameter plastic with steel threaded inserts
FINISH:	Stock colors are Black (-BL) and Metallic Silver (-MS) See page 84 for more color options
PACKAGING:	Base is packaged in 3 boxes



2C3-2230FPR

OPTIONS

CUSTOM HEIGHT:	Specify -CUSTHT1 for height between 5" - 27.75" Specify -CUSTHT2 for height between 27.75" - 40.75"
BAR HEIGHT:	Specify -42
SELF LEVELING GLIDES:	Specify -SLG-M8. See page 73 for information

SIENNA RECTANGLE BASE PRICING

BASE HEIGHT	# OF COLUMNS	PART #	COLUMN DIAMETER	UNIT HEIGHT	PLATE SIZE	RECOMMENDED TOP SIZE	NET WEIGHT	LIST PRICE (EA)
STANDARD	2	2C3-2230FPR	3"	27.75"	22" x 30"	30" - 36" x 42" - 72"	92 lbs	898
BAR HEIGHT	2	2C3-2230FPR-42	3"	40.75"	22" x 30"	30" - 36" x 42" - 72"	101 lbs	1,024
CUSTOM HEIGHT	2	-CUSTHT1	For height between 5" - 27.75"					+ 136
	2	-CUSTHT2	For height between 27.75" - 40.75"					+ 262
GLIDES		-SLG-M8	Self-leveling Glides					+ 126

SIENNA T-LEG & C-LEG

Sienna T-Leg and C-Leg feature an elegant foot design for conference or training room tables. The bases are constructed with 3" diameter columns and a floor plate made of heavy-duty 3/8" thick laser-cut solid steel.



2C3-2LGTL-36

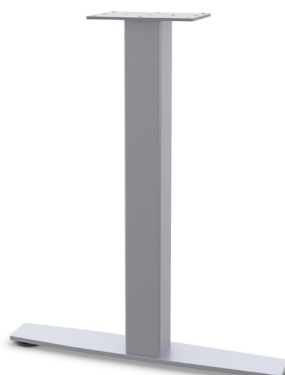

LGTL-24

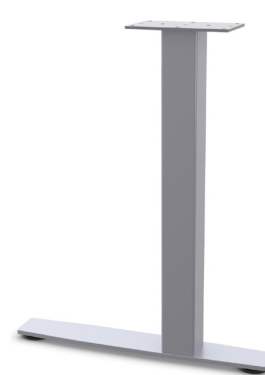

LGCL-24

■ FEATURES

UNIT HEIGHT:	27.75" 40.75"
WELDED	Single column 5" x 8"
MOUNTING PLATE:	Dual column 6" x 6"
COLUMN:	Single column 2-3/4" x 2-3/4" square Dual column 3" diameter
LEVELING GLIDES:	2-3/8" diameter plastic for leveling on uneven floors
FINISH:	Stock colors are Black (-BL) and Metallic Silver (-MS) See page 84 for more color options
PACKAGING:	2-floor plates per box Single column bases are packaged in 2 boxes Dual column bases are packaged in 3 boxes Priced individually

■ OPTIONS

CUSTOM HEIGHT FOR 1 & 2 COLUMN:	Specify -CUSTHT1 for height between 5" - 27.75" Specify -CUSTHT2 for height between 27.75" - 40.75"
BAR HEIGHT FOR 1 & 2 COLUMN:	Specify -42.
CASTERS:	Specify -SC. 2.5" locking skate wheel caster with 112 lbs capacity
SELF LEVELING GLIDES:	Specify -SLG-M8. See page 73 for information

■ SIENNA T-LEG & C-LEG BASE PRICING

LEG TYPE	LEG HEIGHT	PART #	UNIT HEIGHT	BASE SPREAD	RECOMMENDED TOP SIZE	NET WEIGHT	LIST PRICE (EACH)
T-LEG SINGLE COLUMN	STANDARD HEIGHT	LGTL-18	27.75"	16"	18" - 20"D x 24" - 120"W	15 lbs	240
		LGTL-24	27.75"	22"	24" D x 36" - 84"W	17 lbs	260
		LGTL-30	27.75"	26"	30" - 36"D x 36" - 84"W	18 lbs	272
		LGTL-36	27.75"	32"	36"D x 42" - 96"W	20 lbs	306
	BAR HEIGHT	LGTL-18-42	40.75"	16"	18" - 20"D x 24" - 120"W	18 lbs	303
		LGTL-24-42	40.75"	22"	24" D x 36" - 84"W	20 lbs	323
		LGTL-30-42	40.75"	26"	30" - 36"D x 36" - 84"W	21 lbs	335
		LGTL-36-42	40.75"	32"	36"D x 42" - 96"W	23 lbs	369
C-LEG SINGLE COLUMN	STANDARD HEIGHT	LGCL-24	27.75"	22"	24"D x 36" - 84"W	17 lbs	260
		LGCL-30	27.75"	26"	30" - 36"D x 36" - 84"W	18 lbs	272
	BAR HEIGHT	LGCL-24-42	40.75"	22"	24"D x 36" - 84"W	20 lbs	323
		LGCL-30-42	40.75"	26"	30" - 36"D x 36" - 84"W	21 lbs	335
OPTIONS	CUSTOM HEIGHT	-CUSTHT1	For height between 5" - 27.75"				+ 68
		-CUSTHT2	For height between 27.75" - 40.75"				+ 131
	CASTERS	-SC	Skate Casters				+ 64
	GLIDES	-SLG-M8	Self-Leveling Glides				+ 42

■ SIENNA 2T-LEG BASE PRICING

LEG TYPE	LEG HEIGHT	PART #	UNIT HEIGHT	BASE SPREAD	RECOMMENDED TOP SIZE	NET WEIGHT	LIST PRICE (EACH)
T-LEG DUAL COLUMN	STANDARD HEIGHT	2C3-2LGTL-36	27.75"	32"	30" - 36"D x 42" - 96"W	29 lbs	432
	BAR HEIGHT	2C3-2LGTL-36-42	40.75"	32"	30" - 36"D x 42" - 96"W	35 lbs	558
OPTIONS	CUSTOM HEIGHT	-CUSTHT1	For height between 5" - 27.75"				+ 136
		-CUSTHT2	For height between 27.75" - 40.75"				+ 262
	CASTERS	-SC	Skate Casters				+ 64
	GLIDES	-SLG-M8	Self-leveling Glides				+ 42

SQUARE END BASE

Fabricated 14 gauge 2" x 1" rectangular tubular steel with threaded inserts for glides. Welded construction. Bases mount flush with the table edge.



RSSB-24



Detail: base placement

■ FEATURES

UNIT HEIGHT:	27.75"
WELDED MOUNTING PLATE:	4-3/4" x 3-1/2" x 7/32"
COLUMN:	14 gauge steel, 2" x 1" rectangular tube profile
LEVELING GLIDES:	1-3/8" diameter nylon glide
FINISH:	Stock color is Metallic Silver See page 84 for more color options
PACKAGING:	Bases are packaged 2 per box, priced individually

■ SQUARE END BASE PRICING

PART #	BASE SPREAD	RECOMMENDED TOP DEPTH	NET WEIGHT	LIST PRICE (EACH)
RSSB-24	24"	24"	14 lbs	311
RSSB-30	30"	30"	15 lbs	339

SQUARE H-LEG

Fabricated 14 gauge 2" x 1" rectangular tubular steel with rectangular adjustable glides.
Welded construction. Bases mount flush with the table edge.



RSHL-24



Detail: base placement



Detail: rectangular adjustable glide

■ FEATURES

UNIT HEIGHT:	27.75"
WELDED MOUNTING PLATE:	4-3/4" x 3-1/2" x 7/32" steel
COLUMN:	14 gauge steel, 2" x 1" rectangular tube profile
LEVELING GLIDES:	1-3/8" diameter nylon glide
FINISH:	Stock color is Metallic Silver See page 84 for more color options
PACKAGING:	Bases are packaged 2 per box, priced individually

■ SQUARE H-LEG PRICING

PART #	BASE SPREAD	RECOMMENDED TOP DEPTH	NET WEIGHT	LIST PRICE (EACH)
RSHL-24	24"	24"	14 lbs	275
RSHL-30	30"	30"	15 lbs	311

STRUCTURE T-LEG & C-LEG

Structure bases present a clean and elegant look that complements various interiors. They feature 14 gauge 2" x 1" rectangular steel, bolted welded construction, and threaded inserts for glides.

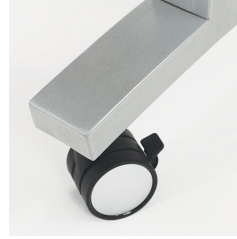

Caster



RS2T-24



RS2T-24-C



RS2C-24

■ FEATURES

- UNIT HEIGHT: 27.75"
- WELDED MOUNTING PLATE: 5" x 11" x 7/32" steel
- COLUMN: 14 gauge steel, 2" x 1" rectangular tube profile
- LEVELING GLIDES: 1-3/8" diameter nylon glide
- CASTERS: 1-3/4" dual-wheel locking caster with silver cap, 112 lbs capacity
- FINISH: Stock color is Metallic Silver
See page 84 for more color options
- PACKAGING: Bases are packaged 2 per box, priced individually

■ OPTIONS

- CASTERS: Specify -C2

■ STRUCTURE T-LEG & C-LEG PRICING

LEG TYPE	PART #	BASE SPREAD	RECOMMENDED TOP SIZE	NET WEIGHT	LIST PRICE (EACH)
T-LEG	RS2T-18	16"	18" D x 48" - 84W	10 lbs	227
	RS2T-24	22"	24" D x 36" - 84W	11 lbs	234
	RS2T-30	26"	30" D x 36" - 84W	12 lbs	242
	RS2T-24-C2 with casters	22"	24" D x 36" - 84W	11 lbs	270
	RS2T-30-C2 with casters	26"	30" D x 36" - 84W	12 lbs	278
C-LEG	RS2C-24	22"	24" D x 36" - 84W	11 lbs	213
	RS2C-30	26"	30" D x 36" - 84W	12 lbs	242
	RS2C-24-C2 with casters	22"	24" D x 36" - 84W	11 lbs	249
	RS2C-30-C2 with casters	26"	30" D x 36" - 84W	12 lbs	278

STRUCTURE POST LEG

Fabricated 14 gauge 2" x 1" rectangular tubular steel post legs. Welded construction.

FEATURES

UNIT HEIGHT:	27.75"
WELDED	
MOUNTING PLATE:	4" x 4" x 7/32"
COLUMN:	14 gauge steel, 2" x 1" rectangular tube profile
LEVELING GLIDES:	Rectangular adjustable glide
CASTERS:	1-3/4" dual-wheel locking caster with silver cap, 112 lbs capacity
FINISH:	Stock color is Metallic Silver See page 84 for more color options
PACKAGING:	Bases are packaged 4 per box, priced individually



Detail: rectangular adjustable glide

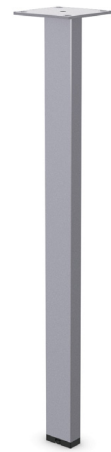

RSP

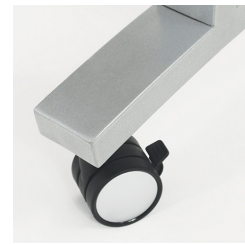

Caster

STRUCTURE POST LEG PRICING

PART #	UNIT HEIGHT	COLUMN SIZE	NET WEIGHT	LIST PRICE (EACH)
RSP	27.75"	2" x 1"	5 lbs	101
RSP-C2 with casters	27.75"	2" x 1"	5 lbs	106

STRUCTURE 4X-BASE

Structure bases present a clean and elegant look that complements various interiors. Structure X-Base features 14 gauge 2" x 1" rectangular columns welded to a mounting plate. The one-piece foot is bolted to a column and features threaded inserts for glides.



RS4X-24-16



RS4X-24

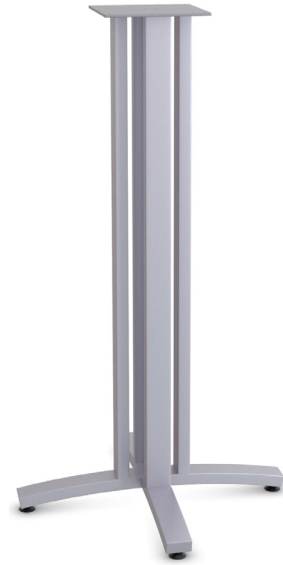

RS4X-24-42

■ FEATURES

UNIT HEIGHT:	14.75" Occasional Height 27.75" Standard Height 40.75" Bar Height
WELDED MOUNTING PLATE:	8" x 8" x 7/32"
COLUMN:	14 gauge steel, (4) 2" x 1" rectangular tube profile
LEVELING GLIDES:	1-3/8" diameter nylon glide
FINISH:	Stock color is Metallic Silver See page 84 for more color options
PACKAGING:	Bases are packaged in 2 boxes

■ STRUCTURE 4X BASE PRICING

BASE TYPE	PART #	UNIT HEIGHT	BASE SPREAD	RECOMMENDED TOP SIZE	NET WEIGHT	LIST PRICE (EACH)
OCCASIONAL HEIGHT	RS4X-24-16	14.75"	22" x 22"	24"	12 lbs	607
	RS4X-30-16	14.75"	26" x 26"	30"	13 lbs	630
	RS4X-36-16	14.75"	32" x 32"	36"	14 lbs	689
	RS4X-42-16	14.75"	38" x 38"	42" - 48"	15 lbs	754
STANDARD HEIGHT	RS4X-24	27.75"	22" x 22"	24"	16 lbs	658
	RS4X-30	27.75"	26" x 26"	30"	17 lbs	681
	RS4X-36	27.75"	32" x 32"	36"	18 lbs	740
	RS4X-42	27.75"	38" x 38"	42" - 48"	19 lbs	805
BAR HEIGHT	RS4X-24-42	40.75"	22" x 22"	24"	21 lbs	722
	RS4X-30-42	40.75"	26" x 26"	30"	22 lbs	745
	RS4X-36-42	40.75"	32" x 32"	36"	23 lbs	804
	RS4X-42-42	40.75"	38" x 38"	42" - 48"	24 lbs	869

STRUCTURE CUBE

Structure bases present a clean and elegant look that complements various interiors. Structure Cube base features 14 gauge 2" x 1" rectangular steel, bolted/welded construction, and threaded inserts for glides.



RSXO-36

■ FEATURES

UNIT HEIGHT:	27.75"
WELDED MOUNTING PLATE:	4" x 4" x 7/32"
COLUMN:	14 gauge steel, 2" x 1" rectangular tube profile
LEVELING GLIDES:	1-3/8" diameter nylon glide
FINISH:	Stock color is Metallic Silver See page 84 for more color options
PACKAGING:	Bases are packaged 1 per box

■ STRUCTURE CUBE PRICING

PART #	BASE SPREAD	RECOMMENDED TOP SIZE	NET WEIGHT	LIST PRICE (EACH)
RSXO-32	32" x 32"	36" - 42"	30 lbs	535
RSXO-36	36" x 36"	48" - 54"	31 lbs	600
RSXO-42	42" x 42"	60" - 72"	35 lbs	681

SPRING CLIP HEIGHT ADJUSTABLE BASES

Bolted construction 14 gauge tubular steel. Legs adjust in 1" increments by depressing the spring clip pin to release the outer column for height adjustment. When realigned with the outer column holes, the pin snaps back into a locking position. A thumbscrew locks the column in place.



SPYL-AH



SPYL-AH-C



TL-18AH



2TL-24AH



1ATL-24AH

■ FEATURES

ADJUSTMENT RANGE:	24.75" to 34.75"
WELDED MOUNTING PLATE:	7/23" steel
COLUMN:	2" diameter on outer column
LEVELING GLIDES:	1-3/8" diameter plastic with steel threaded inserts
FINISH:	Stock color is Black See page 84 for more color options, excludes Black Wrinkle
PACKAGING:	Bases are packaged 2 per box SPYL-AH are packaged 4 per box Priced individually

■ OPTIONS

CASTERS:	The base height will increase 2" See page 73 for caster options Specify -C CL-AH, 2CL-AH and 2TL-AH bases Specify -SC for SPYL-AH and 1ATL-AH
----------	--

■ SPRING CLIP HEIGHT ADJUSTABLE BASES PRICING

LEG TYPE	PART #	BASE SPREAD	MOUNTING PLATE SIZE	RECOMMENDED TOP DEPTH	NET WEIGHT	LIST PRICE
POST LEG	SPYL-AH	1.5" DIA	4" x 4"	-	6 lbs	142
	SPYL-AH-SC Skate Caster	1.5" DIA	4" x 4"	-	6 lbs	142
C-LEG	CL-18-AH	16"	5" x 8"	18" - 22"	9 lbs	288
	CL-24-AH	22"	5" x 8"	24" - 28"	10 lbs	291
	CL-30-AH	26"	5" x 8"	28" - 30"	11 lbs	295
	-C	Caster				+ 38
T-LEG	TL-18-AH	16"	5" x 8"	18" - 20"	9 lbs	288
	TL-20-AH	18"	5" x 8"	20" - 22"	9 lbs	288
	TL-22-AH	20"	5" x 8"	22" - 24"	10 lbs	291
	TL-24-AH	22"	5" x 8"	24" - 28"	10 lbs	291
	TL-30-AH	26"	5" x 8"	28" - 30"	10 lbs	295
	-C	Caster				+ 38
ARCHED LEG	1ATL-18-AH	16"	5" x 8"	-	6 lbs	276
	1ATL-24-AH	22"	5" x 8"	18" - 22"	9 lbs	280
	1ATL-30-AH	26"	5" x 8"	24" - 28"	10 lbs	283
	-SC	Skate Caster				+ 64
C-LEG DUAL COLUMN	2CL-24-AH	22"	(2) 5" x 8"	18" - 22"	11 lbs	463
	2CL-30-AH	26"	(2) 5" x 8"	24" - 28"	9 lbs	466
	-C	Caster				+ 38
T-LEG DUAL COLUMN	2TL-24-AH	22"	(2) 5" x 8"	20" - 22"	9 lbs	463
	2TL-30-AH	26"	(2) 5" x 8"	22" - 24"	10 lbs	466
	2TL42-AH	36"	(2) 5" x 8"	24" - 28"	10 lbs	487
	2TL-48-AH	48"	(2) 5" x 8"	28" - 30"	10 lbs	499
	-C	Caster				+ 38

PATRIOT ELECTRIC HEIGHT ADJUSTABLE BASE

The Patriot Electric base offers an optimal solution for any adjustable height requirement in the office. This GSA-approved base is an excellent first step towards improving the efficiency and well-being of your organization while remaining budget-conscious.



PAT-3STG-24T



2-stage



3-stage



Up/down switch (standard)



Programmable digital switch

FEATURES

FEET:	T-Leg C-Leg
COLUMN:	2-stage base: height range 27" - 46" with 19" stroke 3-stage base: height range 24" - 47" with 24" stroke
CONTROLLER:	Up-down switch comes standard or optional programmable switch
FINISH:	Stock colors are Black, specify -B; and Metallic Silver specify -MS See page 85 for additional colors available with an extended lead time
PACKAGING:	2 column base is packaged in 1 box, 3 column bases are packed in 3 boxes

ELECTRICAL INFORMATION

MOTOR:	Dual motor	MOTOR NOISE:	<43 dB
MAX LIFTING SPEED:	1-2/8"/sec	POWER CONSUMPTION:	.3W
OVERLOAD PROTECTION:	200 lbs	FUNCTIONS:	Soft-Start-Stop

OPTIONS

CONTROLLER:	Specify PAT-DIG-HS for Digital Display with Memory Preset
STEEL TABLE SUPPORT:	42", 54"
CASTERS:	Specify PAT-C



GS-28F-0015W

■ PATRIOT ELECTRIC HEIGHT ADJUSTABLE BASES PRICING

STAGE	PART #	BASE TYPE	# OF COLUMNS	BASE SPREAD	RECOMMENDED TOP SIZE	NET WEIGHT	LIST PRICE (EACH)	
2-STAGE	PAT-2STG-24T	T-Leg	2	22"	24" D x 48-84" W	55 lbs	1,647	
	PAT-2STG-30T	T-Leg	2	28"	30" D x 48-84" W	55 lbs	1,661	
	PAT-2STG-3COL-24T	T-Leg	3	22"	24" D x 60-72" W	80 lbs	2,533	
	PAT-2STG-3COL-30T	T-Leg	3	28"	30" D x 60-72" W	80 lbs	2,547	
	PAT-2STG-24C	C-Leg	2	22"	24" D x 48-84" W	55 lbs	1,647	
	PAT-2STG-30C	C-Leg	2	28"	30" D x 48-84" W	55 lbs	1,661	
	PAT-2STG-3COL-24C	C-Leg	3	22"	24" D x 60-72" W	80 lbs	2,533	
	PAT-2STG-3COL-30C	C-Leg	3	28"	30" D x 60-72" W	80 lbs	2,547	
3-STAGE	PAT-3STG-24T	T-Leg	2	22"	24" D x 48-84" W	55 lbs	1,785	
	PAT-3STG-30T	T-Leg	2	28"	30" D x 48-84" W	55 lbs	1,799	
	PAT-3STG-3COL-24T	T-Leg	3	22"	24" D x 60-72" W	80 lbs	2,686	
	PAT-3STG-3COL-30T	T-Leg	3	28"	30" D x 60-72" W	80 lbs	2,700	
	PAT-3STG-24C	C-Leg	2	22"	24" D x 48-84" W	55 lbs	1,785	
	PAT-3STG-30C	C-Leg	2	28"	30" D x 48-84" W	55 lbs	1,799	
	PAT-3STG-3COL-24C	C-Leg	3	22"	24" D x 60-72" W	80 lbs	2,686	
	PAT-3STG-3COL-30C	C-Leg	3	28"	30" D x 60-72" W	80 lbs	2,700	
OPTIONS	PAT-DIG-HS	Digital Display with Memory Preset						+ 110
	STEEL TABLE SUPPORT	42"						+ 73
		54"						+ 82
	PAT-C	Casters						+ 146

Patriot Electric & Liberty Electric Bases Only 1 - 3 \$55 each | 4-15 \$33 each | 16 - 50 \$27 each | 51 + \$16 each
 FOB: Alpharetta, GA; PPD & ADD

LIBERTY ELECTRIC HEIGHT ADJUSTABLE BASE

Liberty Electric bases are made in the USA and filled with the versatility to optimize various work environments. Exceptional value, dual motors, and three metal finishes make it the industry's #1 choice for sit-to-stand tables.



LIBERTY-MS



Up/down switch (standard)



Programmable digital switch

FEATURES

- FEET: T-Leg
- COLUMN: 2-stage base: height range 27" - 46" with 19" stroke
- CONTROLLER: Up-down switch comes standard; or optional programmable switch
- FINISH: Stock colors are Metallic Silver, specify -MS, Black, specify -B, and White specify -W
- PACKAGING: Bases are packaged in 1 box | Bases are pre-assembled

ELECTRICAL INFORMATION

- MOTOR: Dual motor
- CONTROLLER: Up-down switch comes standard
Specify PAT-DIG-HS for Digital Display with Memory Preset

LIBERTY ELECTRIC HEIGHT ADJUSTABLE BASES PRICING

PART #	BASE TYPE	# OF COLUMNS	BASE SPREAD	RECOMMENDED TOP SIZE	NET WEIGHT	LIST PRICE (EACH)
LIBERTY-B	T-Leg	2	22.24"	24" D x 48-72" W	55 lbs	1,207
LIBERTY-MS	T-Leg	2	22.24"	30" D x 48-72" W	55 lbs	1,207
LIBERTY-W	T-Leg	2	22.24"	24" D x 60-72" W	55 lbs	1,207
PAT-DIG-HS	Digital Display with Memory Preset					+ 110

Patriot Electric & Liberty Electric Bases Only 1 - 3 \$55 each | 4-15 \$33 each | 16 - 50 \$27 each | 51 + \$16 each
 FOB: Alpharetta, GA; PPD & ADD

FOLDING T-LEG & C-LEG

The molded folding mechanism is operated by a lever that can be pushed up by hand or foot, making a positive connection in both open and closed positions allowing legs to lay flat when the table is 60" or longer. Rising brackets must be used to fold smaller tables.



CL-30-GFM

TL-30-GFM

FEATURES

UNIT HEIGHT:	27.75"
COLUMN:	2" diameter
MECHANISM DIMENSION:	9" x 8" x 3"
RISING BRACKET:	Specify -RISER, is necessary for folding tables under 60" long
LEVELING GLIDES:	1-3/8" diameter plastic with steel threaded inserts
FINISH:	Stock color is Black. See page 84 for more color options
PACKAGING:	Bases are packaged in multiple boxes, priced individually

OPTIONS

CASTERS:	Specify -C. 2" dual-wheel locking caster 112 lbs capacity
----------	---

FOLDING T-LEG & C-LEG BASES PRICING

	PART #	UNIT HEIGHT	COLUMN DIAMETER	BASE SPREAD	RECOMMENDED TOP DEPTH	NET WEIGHT	LIST PRICE	
C-LEG	CL-18-GFM	27.75"	2"	16"	18" - 22"	8.5 lbs	427	
	CL-24-GFM	27.75"	2"	22"	24" - 28"	9.5 lbs	430	
	CL-30-GFM	27.75"	2"	26"	28" - 30"	10 lbs	434	
T-LEG	TL-18-GFM	27.75"	2"	16"	18" - 20"	8.5 lbs	427	
	TL-20-GFM	27.75"	2"	18"	20" - 22"	8.5 lbs	427	
	TL-22-GFM	27.75"	2"	20"	22" - 24"	9.5 lbs	430	
	TL-24-GFM	27.75"	2"	22"	24" - 28"	9.5 lbs	430	
	TL-30-GFM	27.75"	2"	26"	28" - 30"	10 lbs	434	
OPTIONS	-C	Casters						+ 38

KINGSTON FLIP BASE

The Kingston Flip base includes a set of two legs, a heavy tubular steel beam, a single-point release dual lock mechanism, and two hinges. The heavy-duty beam prevents the tabletop from sagging. Save space by nesting tables!



CLSF-2460-C



T-Leg nested tables



Arched-Leg flipped table



Release mechanism

■ FEATURES

UNIT HEIGHT:	27.75"
MOUNTING PLATE:	5" x 8" x 7/32"
CASTERS:	Standard 2" locking casters are included with T-Legs. Arched T-Legs come standard with 3" locking skate wheel casters Both casters have a 112 lbs capacity
FINISH:	Stock color is Black (-BL) and Metallic Silver (-MS) See page 84 for more color options
PACKAGING:	Bases are packaged 1 set (2 legs) in 1 box and beam in a separate box

■ KINGSTON FLIP C-LEG & T-LEG BASES PRICING

LEG TYPE	PART #	BASE SPREAD	RECOMMENDED TOP SIZE	NET WEIGHT	LIST PRICE
T-LEG	TLSF-1848	16" x 43"	18" x 48"	29 lbs	1,049
	TLSF-1860	16" x 55"	18" x 60"	31 lbs	1,067
	TLSF-1872	16" x 67"	16" x 72"	34 lbs	1,086
	TLSF-2448	22" x 43"	24" x 48"	29 lbs	1,049
	TLSF-2460	22" x 55"	24" x 60"	33 lbs	1,067
	TLSF-2472	22" x 67"	24" x 72"	36 lbs	1,086
	TLSF-3048	26" x 43"	30" x 48"	32 lbs	1,049
	TLSF-3060	26" x 55"	30" x 60"	34 lbs	1,067
	TLSF-3072	26" x 67"	30" x 72"	37 lbs	1,086
C-LEG	CLSF-1848	16" x 43"	18" x 48"	29 lbs	1,049
	CLSF-1860	16" x 55"	18" x 60"	31 lbs	1,067
	CLSF-1872	16" x 67"	16" x 72"	34 lbs	1,086
	CLSF-2448	22" x 43"	24" x 48"	29 lbs	1,049
	CLSF-2460	22" x 55"	24" x 60"	33 lbs	1,067
	CLSF-2472	22" x 67"	24" x 72"	36 lbs	1,086
	CLSF-3048	26" x 43"	30" x 48"	32 lbs	1,049
	CLSF-3060	26" x 55"	30" x 60"	34 lbs	1,067
	CLSF-3072	26" x 67"	30" x 72"	37 lbs	1,086
ARCHED LEG	ATLSF-2448	22" x 43"	24" x 48"	31 lbs	1,191
	ATLSF-2460	22" x 55"	24" x 60"	33 lbs	1,209
	ATLSF-2472	22" x 67"	24" x 72"	36 lbs	1,228
	ATLSF-3048	26" x 43"	30" x 48"	32 lbs	1,191
	ATLSF-3060	26" x 55"	30" x 60"	34 lbs	1,209
	ATLSF-3072	26" x 67"	30" x 60"	37 lbs	1,228

CONVERTIBLE BASE

The Convertible Base's sleek design and construction deliver space efficiency; its unique structure allows straight-on nesting in the flipped position. Each table only takes up 4.5" of space. The base includes locking skate casters for easy mobility. A heavy-duty beam prevents the tabletop from sagging.



CV-2460



Release mechanism



Nested Convertible Tables

FEATURES

- STRUCTURE:** 14 gauge 1.5" diameter tubular columns bent and welded together at a 190° angle. The two end bases are connected with a heavy-duty beam with two hinges and one single point release mechanism in the center
- MOUNTING PLATE:** 5" x 8" x 7/32"
- CASTERS:** Black 3" locking skate wheel casters, 112 lbs capacity
- FINISH:** Stock color is Black. See page 84 for more color options
- PACKAGING:** Bases are packaged 1 set (2 legs) in 1 box and beam in a separate box

CONVERTIBLE BASE PRICING

PART #	BASE SPREAD	RECOMMENDED TOP SIZE	NET WEIGHT	LIST PRICE
CV-1848	18" x 43"	18" x 48"	29 lbs	1,102
CV-1860	18" x 55"	18" x 60"	31 lbs	1,119
CV-1872	18" x 67"	16" x 72"	34 lbs	1,138
CV-2448	23.5" x 43"	24" x 48"	32 lbs	1,119
CV-2460	23.5" x 55"	24" x 60"	35 lbs	1,138
CV-2472	23.5" x 67"	24" x 72"	37 lbs	1,159
CV-3048	27.5" x 43"	30" x 48"	32 lbs	1,147
CV-3060	27.5" x 55"	30" x 60"	35 lbs	1,165
CV-3072	27.5" x 67"	30" x 72"	37 lbs	1,184

TRANSFORM-2 BASE

Transform-2 is a versatile contemporary base with straight-on nesting in the flip-top application. Its lightweight material, casters, and one-handed activation allow anyone to flip and move tables quickly. A perforated steel modesty panel is an integral part of the base providing privacy and an elegant look simultaneously. In addition, a continuous heavy-duty beam prevents the top from sagging.



TF2-2460



Release Mechanism



Nested Transform-2 Tables

FEATURES

- STRUCTURE: 14 gauge 1.5" diameter tubular legs are connected by a modesty panel and a stretcher with the flip-top mechanism. The modesty panel attaches to the legs and extends 14" below the tabletop
- UNIT HEIGHT: 28.75"
- CASTERS: Black dual-wheel locking 2-1/4" diameter, 112 lb capacity
- FINISH: Stock colors are Black (-BL) and Metallic Silver (-MS)
- PACKAGING: Each base is packaged in 2 boxes

TRANSFORM-2 BASE PRICING

PART #	BASE SPREAD	RECOMMENDED TOP SIZE	NET WEIGHT	LIST PRICE
TF2-1848	17" x 47"	18" x 48"	34 lbs	574
TF2-1860	17" x 59"	18" x 60"	38 lbs	622
TF2-1872	17" x 71"	18" x 72"	42 lbs	671
TF2-2448	19" x 47"	24" x 48"	35 lbs	669
TF2-2460	19" x 59"	24" x 60"	39 lbs	720
TF2-2472	19" x 71"	24" x 72"	43 lbs	780

CASTERS



■ STANDARD CASTER

2" locking dual-wheel hooded casters, nylon.
25 mm x 8mm stem, 112 lbs capacity.

PART #	LIST PRICE
C-1	19



■ LOCKING SKATE WHEEL CASTER

3" in-line skate wheel caster with gray ribbed core.
25mm x 8 mm stem, 112 lbs capacity.

PART #	LIST PRICE
SC-1	32



■ HARD SURFACE CASTER

2" locking dual-wheel hooded caster with soft polyurethane for use on hard surfaces.
22 mm x 8mm stem, 112 lbs capacity.

PART #	LIST PRICE
HSC-1	25

GLIDES

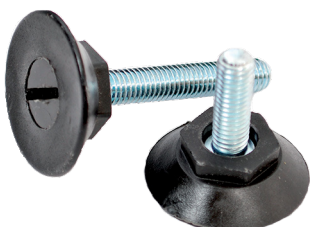

■ ADJUSTABLE LEVELING GLIDE

Metric thread: can be used on most Special-T table bases, 1-3/8" diameter nylon cap; 2" long.

PART #	LIST PRICE
ALG-1	4



■ SELF-LEVELING GLIDE

Automatically stabilizes the table. Easy to install. Requires no adjustment. Automatically adjusts 5/16" on any uneven surface. 1-3/8" diameter nylon cap. SLG-M8 features an 8 mm stem.

PART #	LIST PRICE
SLG-1	21
SLG-M8	21

PERFORATED STEEL MODESTY PANELS

Perforated steel modesty panels provide stability, privacy, and style to any table. The panel attaches directly to the work surface with screws. It is fabricated with 18 gauge steel and includes a built-in wire channel for wire management.

FEATURES

- STRUCTURE:** Perforation pattern is 3/16" diameter holes spaced 1-3/4" apart. Cable cutout is 1-1/2" x 3". The 3" x 3" wire channel runs through the bottom of the modesty panel
- PANEL HEIGHT:** 10" H
- ATTACHMENT:** Modesty panel attaches to the top with screws
- FINISH:** Stock color is Black
See page 84 for more color options
- PACKAGING:** Packaged 2 per box, priced individually



PERFORATED STEEL MODESTY PANELS PRICING

PART #	LENGTH	HEIGHT	RECOMMENDED TOP SIZE	# OF CABLE CUTOUTS	CABLE CUTOUT POSITION	NET WEIGHT	LIST PRICE
MP-1030	30"	10"	30"	1	center	10 lbs	190
MP-1042SF	42"	10"	42"	1	center	13 lbs	247
MP-1048SF	48"	10"	48"	1	center	14 lbs	288
MP-1054SF	54"	10"	54"	1	center	15 lbs	330
MP-1060SF	60"	10"	60"	2	12" from each end	16 lbs	347
MP-1066SF	66"	10"	66"	2	12" from each end	20 lbs	388
MP-1072SF	72"	10"	72"	2	12" from each end	22 lbs	424
MP-1084SF	84"	10"	84"	3	1 in the center 2 12" from each end	25 lbs	490
MP-1096SF*	96"	10"	96"	3	1 in the center 2 12" from each end	29 lbs	533

*An Oversize Fee has been implemented by freight carriers for all LTL shipments for pallets 8' and over.
96"-108" - additional \$250.00 | 109" -168" - additional \$350.00 | Per custom pallet

FROSTED ACRYLIC MODESTY PANELS AND PRIVACY SCREENS

Frosted Acrylic Privacy Screens and Modesty panels provide an attractive and durable option to traditional acrylic products. The superiority of Frosted Acrylic is in its excellent light diffusion, rigidity, and smudge-resistant surface. It is truly a high-quality product designed for years of performance.

FEATURES

PANELS

STRUCTURE: Scratch and smudge resistant with smooth edges and corners

COLOR: Frosted White

SIZE: 14" H x 47" L, 59" L, 71" L ; 3/8" thick

BRACKETS

MATERIAL: Extruded aluminum

STRUCTURE: Durable, permanent attachment with 2 screws per bracket underneath the table for a seamless look when used in combination with the privacy screens and modesty panels. Compatible with 1" - 1.25" tabletops

2 BRACKETS Are included for 47" and 59" panels

3 BRACKETS Are included for 71" panels

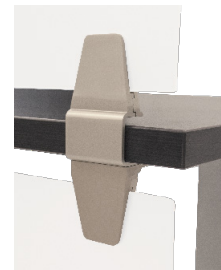

FROSTED ACRYLIC MODESTY PANELS AND PRIVACY SCREENS PRICING

TYPE	PART #	SIZE	RECOMMENDED TOP SIZE	NET WEIGHT	LIST PRICE
MODESTY PANEL	AP-1248-MP	12" x 47"	48" L	5 lbs	439
	AP-1260-MP	12" x 59"	60" L	6 lbs	512
	AP-1272-MP	12" x 71"	72" L	7 lbs	586
PRIVACY SCREEN	AP-1448-PS-BR	14" x 47"	48" L	5 lbs	400
	AP-1460-PS-BR	14" x 59"	60" L	6 lbs	466
	AP-1472-PS-BR	14" x 71"	72" L	7 lbs	533

LAMINATE MODESTY PANELS

Laminate modesty panels can match the tabletop or make a statement with a different color laminate.



■ FEATURES

- PANEL SIZE:** 3/4" thick, 10" high and 1/4" shorter than the top length
- ATTACHMENT:** Permanently attaches directly to the table
Mounting brackets are included
- COLORS:** Any standard WilsonArt or Formica laminate on both sides
- EDGE:** PVC

■ LAMINATE MODESTY PANELS PRICING

PART #	LENGTH	RECOMMENDED TOP LENGTH	NET WEIGHT	LIST PRICE
MPL-1036	35.75"	36"	7 lbs	226
MPL-1042	41.75"	42"	8 lbs	242
MPL-1048	47.75"	48"	9 lbs	262
MPL-1054	53.75"	54"	10 lbs	268
MPL-1060	59.75"	60"	11 lbs	270
MPL-1066	65.75"	66"	12 lbs	293
MPL-1072	71.75"	72"	13 lbs	344
MPL-1084	83.75"	84"	16 lbs	404
MPL-1096*	95.75"	96"	18 lbs	462

*An Oversize Fee has been implemented by freight carriers for all LTL shipments for pallets 8' and over.
96"-108" - additional \$250.00 | 109" -168" - additional \$350.00 | Per custom pallet

BURELE™



Burele brings customizability to a new level. That's why it lives up here on the work surface, where work gets done. It offers blended power options, including USB ports for phones, tablets, and more. Personalize its sleek, high-gloss plastic finish with color, artwork, and messaging.

OPTIONS

- 2 Power, QuickShip in Black or White

DESCRIPTION

- Colors: Black or White
- Removable above surface mount
- 72" plug power cord

CUSTOM FEATURES - CONTACT CUSTOMER SERVICE

- More finish options
- 120" plug power cord



■ BURELE™ PRICING

PART #	COLOR	CONFIGURATION	LIST PRICE
BURELE-2P-72-B	Black	2 Power	219
BURELE-1P1U-72-B	Black	1 Power / 1 USB Duplex	311
BURELE-2P-72-W	White	2 Power	219
BURELE-1P1U-72-W	White	1 Power / 1 USB Duplex	311

EZ POWER

The EZ Power can easily integrate into existing workspaces with a simple clamp-on attachment. For example, a convenient tablet or phone holder is built into a clamp mount to keep your desk organized. In addition, 3-power outlets and 1-USB duplex provide the flexibility to maintain all devices well charged.



DESCRIPTION

- 3 AC 15 Amp receptacle and 3.1 Amp combined USB duplex
- 96" plug power cord
- Surge protection up to 510 Joules
- Colors: Black or White
- Removable above the surface mount
- QuickShip

OPTIONS

- 3 Power / 1 USB Duplex



EZ POWER PRICING

PART #	COLOR	CONFIGURATION	LIST PRICE
EZPOWER-3P1U-B	Black	3 Power / 1 USB Duplex	247
EZPOWER-3P1U-W	White	3 Power / 1 USB Duplex	247

WIRE MANAGEMENT

HORIZONTAL WIRE MANAGEMENT



■ LOOP CLIPS

Package of 4 wire management clips with screws.

PART #	LIST PRICE
WM-LOOPCLIP	5



■ VELCRO LOOP

Package of 4 Velcro hook & loop wire management clips.

PART #	LIST PRICE
WM-VELCRO	14



■ CABLE GRIP

Grip wire manager that holds 5 cords.

PART #	LIST PRICE
WM-CABLE-GRIP	17



■ J-SHAPE WIRE CHANNEL

J-shape wire management channel with double-sided adhesive tape to be fastened under a desk/work surface to keep cables up and out of the way. Available in 4, 5, and 6-foot lengths. 4-5/16" overall flange, 1-3/32" deep, with a serrated finish. The trough is 2-9/16" high. The stock color is Black.

PART #	LIST PRICE
JWM-4	49
JWM-5	61
JWM-6	73



■ LOCKING WIRE CHANNEL

Black 32" plastic latching wire manager.

PART #	LIST PRICE
WM-SNAP-CHANNEL	19

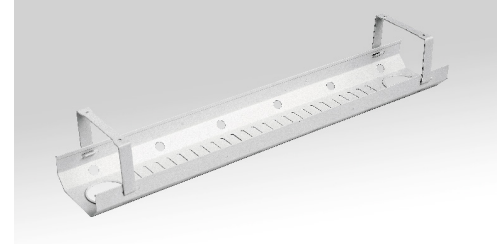

■ WIRE TROUGH

27.6" metal wire trough management unit, available in black and silver.

PART #	COLOR	LIST PRICE
WM-TROUGH-B	Black	35
WM-TROUGH-MS	Metallic Silver	35

■ WIRE TRAY

20" wire management tray available in black or silver.



PART #	COLOR	LIST PRICE
WM-TRAY-20-B	Black	27
WM-TRAY-20-MS	Metallic Silver	27

WIRE MANAGEMENT

VERTICAL WIRE MANAGEMENT



■ LEG CLIP

2" wide leg clip wire manager available in black and silver.

PART #	COLOR	LIST PRICE
WM-LEGCLIP2-B	Black	17
WM-LEGCLIP2-MS	Metallic Silver	17



■ MAGNETIC CHANNEL

2" wide magnetic wire manager available in black and silver.

PART #	COLOR	LIST PRICE
WM-MAG-CHANNEL-B	Black	99
WM-MAG-CHANNEL-MS	Metallic Silver	99

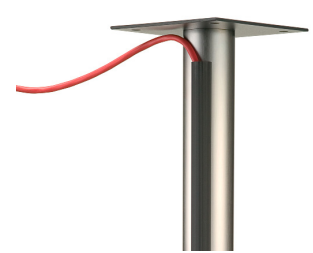

■ 1" WIRE CHANNEL

Adhesive vertical table leg wire manager, 24" long, available in black and gray

PART #	COLOR	LIST PRICE
WM-24-B	Black	62
WM-24-GR	Gray	62

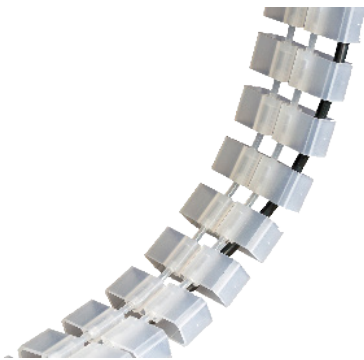

■ ADJUSTABLE SPINE

51" spine wire management conceals and carries wires from under the desk to the floor.

It screws under the desk and comes with a weighted base.

PART #	LIST PRICE
WM-SPINE-TR	231



■ METAL SNAP-ON

Features an easy snap-on installation that allows for repositioning. Two options for 2" and 3" columns with a capacity for multiple power and data cables. 17-3/4" length; available in Black (-BL) and Metallic Silver (-MS) finish.

PART #	LIST PRICE
SNAP-WM for 2" column	81
SNAP-WM3 for 3" column	81

TABLE CONNECTORS



■ QUICK ALIGN TABLE CONNECTOR

Connect two or more tables and add flexibility to any space. 6-1/4" x 2-1/2" steel plate, 2 plastic knobs.

PART #	LIST PRICE
QA	76

TOP SUPPORT



■ STEEL TOP SUPPORT

10 gauge channel, includes screws. Available in 42" or 54" lengths.

PART #	LIST PRICE
STS-42	73
STS-54	82

MONITOR ARMS

FEATURES & BENEFITS

WIDE MOTION RANGE

Monitors can be easily adjusted with a swivel of $\pm 90^\circ$, a tilt from $+75^\circ$ to -45° and 90° pivot movements. Adjust monitors to different heights or angles and portrait or landscape positions.

GAS SPRING LIFT

Counter-balanced gas spring provides effortless one-touch position adjustments and can handle up to 22 lbs. In addition, a simple twist of a screw can modify the Mount's capacity.

INTEGRATED CABLE MANAGEMENT

Wires are not visible inside the cable clips that keep your work surface tidy and clutter-free.



QUICK-RELEASE BRACKET

Makes monitor installation and removal fast and easy. Compatible with all VESA compliant monitors – includes 75mm and 100mm VESA standard mounting plates.

TWO INSTALLATION OPTIONS

Monitor Arms include both desk clamp or grommet options for installation.

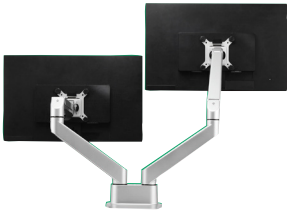
TECHNICAL SPECIFICATIONS AND PRICING

	SINGLE MONITOR ARM FOR 1 MONITOR	DUAL MONITOR ARM FOR 2 MONITORS	SINGLE MONITOR ARM WITH CROSS BAR FOR 2 MONITORS
			
Part Number	MA-S1-A1	MA-S1-A2	MA-S1-X2
List Price	402	708	574
Monitor Size	up to 30"	up to 24"	up to 24"
Weight Capacity	4.4 - 22 lbs. monitor	4.4 - 22 lbs. monitor	4.4 - 22 lbs. monitor
Lift	13-3/8"	13 3/8"	13 3/8"
Tilt	$+75^\circ$ ~ -45°	$+75^\circ$ ~ -45°	$+75^\circ$ ~ -45°
Swivel	$\pm 90^\circ$	$\pm 90^\circ$	$\pm 90^\circ$
Pivot	$\pm 90^\circ$	$\pm 90^\circ$	$\pm 90^\circ$
VESA	75 x 75 100 x 100	75 x 75 100 x 100	75 x 75 100 x 100
N.W.	7.7 lbs.	15 lbs.	11.4 lbs.

ONE DAY QUICK SHIP - TABLETOPS

Table tops feature a durable thermo-fused material for office and restaurant use with several color options and edges. In addition, all tops 60" or longer include a steel top support to prevent the top from sagging.

FEATURES

STRUCTURE: 1" thick top; 45" density particle board core

LAMINATE: 8 low pressure laminate colors with matching PVC edge

PACKAGING: Tops are packaged individually

ONE DAY QUICK SHIP TABLETOPS COLOR OPTIONS



AGED DRIFTWOOD
(-AD)

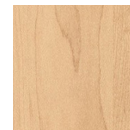

CREMA MAPLE*
(-CM)

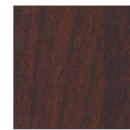

MAHOGANY
(-MHG)

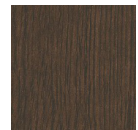

ESPRESSO
(-ESP)



WHITE
(-WHT)

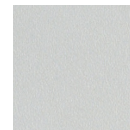

LIGHT GRAY
(-GR)



CANVAS*
(-CNV)



CHINO*
(-CHI)

*Available in 24" x 60", 24" x 72", and 36" x 36"

ONE DAY QUICK-SHIP TABLETOPS WITH MATCHING EDGES PRICING**

TABLE SHAPE	PART #	SIZE	NET WEIGHT	LIST PRICE
RECTANGLE	1DT-1860	18" x 60"	30 lbs	473
	1DT-1872	18" x 72"	36 lbs	536
	1DT-2448	24" x 48"	32 lbs	446
	1DT-2460	24" x 60"	40 lbs	489
	1DT-2472	24" x 72"	48 lbs	575
	1DT-3060	30" x 60"	50 lbs	575
	1DT-3072	30" x 72"	60 lbs	633
SQUARE	1DT-3636	36" x 36"	36 lbs	497
	1DT-4242	42" x 42"	49 lbs	590
ROUND	1DT-36R	36"	28 lbs	534
	1DT-42R	42"	38 lbs	621

**Specify code for color

METAL FINISH COLORS

QUICK SHIP STOCK COLORS



METALLIC SILVER



BLACK

POWDER COAT COLORS

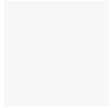

GLOSSY WHITE

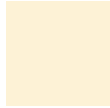

BEIGE



LIGHT TONE



SAND



INNERTONE LIGHT



TAUPE



TAN



MEDIUM TONE



HW PLATINUM



SMOKE



GRAPHITE

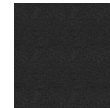

BLACK WRINKLE

METALLIC POWDER COAT COLORS



METALLIC SAND



GUN METAL

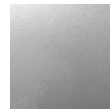

METALLIC PLATINUM

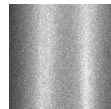

STEEL SILVER

NON-POWDER COAT COLORS



STAINLESS STEEL*

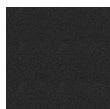

BLACK WRINKLE

NON-STOCK FINISHES LEAD TIME: 10 - 15 BUSINESS DAYS.
Metal finishes vary by base style | Additional charges may apply
Images are representative of the material and may not be an exact match

* Only available for Cast Iron-2 Series ** Not available in powder coat finishes

PATRIOT METAL FINISH COLOR OPTIONS

PATRIOT QUICK SHIP STOCK COLOR



METALLIC SILVER
[MS]
METALLIC SEMI-GLOSS

PATRIOT METAL COLORS



BLACK
[B07]
MATTE



DESIGNER WHITE
[405]
MATTE



SOFT WHITE
[LU]
MATTE



WHITE
[91]
MATTE



ANODIZED SILVER | S09



STARLIGHT SILVER
[S15]
METALLIC SEMI-GLOSS



WARM NEUTRAL GRAY
[WN]
MATTE



TAUPE METALLIC
[504]
METALLIC SEMI-GLOSS



MEDIUM TONE
[MT]
MATTE



METALLIC BRONZE
[EH]
METALLIC SEMI-GLOSS



CLEAR
[CC05]
MATTE



SATIN BRONZE
[SB]
MATTE



ANTHRACITE GRAY
[7016]
GLOSS



GRAPHITE
[G2]
MATTE



CARBON METALLIC
[514]
METALLIC SEMI-GLOSS



BUMPER BLACK
[B05]
GLOSS



COPPER TOP
[1023]
SEMI-GLOSS



ORANGE
[OR01]
GLOSS



RED
[R02]
GLOSS



MOSS GREEN
[G01]
GLOSS



SIGNAL GREEN
[6032]
GLOSS



SERPO GREEN
[G03]
GLOSS

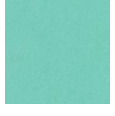

LIGHT GREEN
[6027]
GLOSS



SKY BLUE
[TR1J]
MATTE

NON-STOCK FINISHES LEAD TIME: 10 - 15 BUSINESS DAYS.
Metal finishes for Patriot style bases
Images are representative of the material and may not be an exact match



IMPORTANT INFORMATION

CONVENIENT PAYMENT OPTIONS

Faxed check, Visa, MasterCard, American Express, and Discover

Special-T is an ISO 9000/9001 certified manufacturer; our products meet or exceed all relevant ANSI/BIFMA standards. We are committed to the highest degree of quality and craftsmanship. Our Quality Management System is designed to guarantee the highest price-quality ratio.

TERMS

Upon credit approval, terms are net 30-days from the date of invoice. Before approved credit, payment must be received before shipping. We accept Visa, Master Card, Discover, and American Express. When you provide a faxed or mailed check, you authorize us to use information from your check to make one-time electronic funds transfer from your account or process this transaction as a check. All custom orders require a 50% deposit. COD payment method is not accepted.

LEAD-TIMES

Lead-time for all products in the stocked finish is 24 hours after the order is confirmed. Non-stocked finishes, lead-time is 10-15 business days. Please contact the Special-T Customer Service Department at (888) 705-0777 to check availability. Can expedite specific orders for an additional 10% Expedited Order Fee.

ACKNOWLEDGMENT OF ORDERS

All orders are entered, manufactured, and shipped according to the acknowledgment. Notify Special-T immediately of any discrepancy.

PRICES

All prices are subject to change without notice.

CANCELLATION POLICY

Custom orders are not subject to cancellation.

SHIPMENT INFORMATION

Orders will ship via UPS or a common LTL carrier, whichever is the least expensive. Orders may ship collect on a designated alternative LTL carrier. Special and international shipping arrangements will be made as necessary and noted on the original Purchase Order. All orders are shipped FOB our warehouse. We do not ship COD. The buyer accepts legal responsibility for the merchandise when shipped. Upon receipt, please inspect the shipment thoroughly for visible and possible concealed damage. If a package is lost or damage is discovered, the responsible receiving party should note this with the carrier and file a claim immediately.



WARRANTY & RETURN

WARRANTY

May 15, 2020

To expedite your warranty claims quickly and accurately, go to specialt.net/claims and fill out the Warranty/Freight claim form. All claims must reference the original Purchase Order number and Special-T Sales Order or Invoice number.

Customer Service:



888.705.0777



customerservice@specialt.net

CONTACT INFORMATION

Warranty:



888.705.0777



warranty@specialt.net

Patriot Electric and Liberty Electric Height Adjustable Tables and Bases are warranted to the original purchaser for 10 years from the date of delivery, under normal use for one 8-hour shift per day against manufacturing defects. We will repair or replace, at our discretion, any products that we determine to be defective as a result of faulty workmanship. In no event shall our liability under this warranty exceed the original purchase price of the product determined to be defective. This warranty does not apply where the product has been abused, mishandled, or subjected to use other than that for which it was designed. For purposes of this warranty, normal wear to the product finish shall not be considered a defect.

Table Bases Only. Bases are warranted to the original purchaser for 10 years from the date of delivery, under normal use, against manufacturing defects. We will repair or replace, at our discretion, any products that we determine to be defective as a result of faulty workmanship. In no event shall liability under this warranty exceed the original purchase price of the product determined to be defective. This warranty does not apply where the product has been abused, mishandled, or subjected to use other than that for which it was designed, including excessive weight and top size limitations. This warranty does not apply to normal wear and tear or damage caused by accident, neglect, misuse, or improper installation or operation. There are no other warranties expressed or implied.

Tabletops Only. Tabletops purchased separately are warranted for one (1) year from the original invoice date against poor workmanship and manufacturing defects. We retain the right to replace or repair at our discretion any products or parts thereof which are found defective in materials or workmanship. This warranty becomes invalid for products engineered by the client, whereas the construction method and material specifications of final product assembly adversely affect materials and workmanship. In no event, shall liability under this warranty exceed the original purchase price. This warranty becomes invalid if the product or parts exhibits abuse or improper or unusual use. This warranty is invalid if the product is subject to caustic or abrasive cleaning agents or sharp objects that cause damage. This warranty is invalid if the product is altered from its original condition or the client performs additional processing on the product that results in any alteration from its original condition. This warranty does not cover self-edge tops and/or tops where table legs/bases are more than 60" apart and do not include steel top support. Our tables and tabletops are not for outdoor use. Any damage related to outdoor use is not covered under this warranty. This warranty does not apply to normal wear and tear or damage caused by accident, neglect, misuse, or improper installation or operation. This warranty is expressly made in lieu of any and all other warranties expressed or implied.



WARRANTY & RETURN

WARRANTY

May 15, 2020

Customer Service:



888.705.0777



customerservice@specialt.net

CONTACT INFORMATION

Warranty:



888.705.0777



warranty@specialt.net

Power & Data: All Power and Data components are warranted for 1 year from the date of the original invoice against poor workmanship and manufacturing defects. This warranty becomes invalid for products engineered by the client, whereas the construction method, material specifications of final product assembly adversely affect materials and or workmanship. In no event, shall liability under this warranty exceed the original purchase price. This warranty does not apply to normal wear and tear or damage caused by accident, neglect, misuse, or improper installation or operation.

Monitor Arms are warranted to the original purchaser for 10 years from the delivery date, under normal use for one, 8-hour shift per day, against manufacturing defects. We will repair or replace, at our discretion, any products that we determine to be defective as a result of faulty workmanship. In no event shall our liability under this warranty exceed the original purchase price of the product determined to be defective. This warranty does not apply where the product has been abused, mishandled, or subjected to use other than that for which it was designed. This warranty does not apply to normal wear and tear or damage caused by accident, neglect, misuse, or improper installation or operation.

Chairs: Special-T warrants to the original purchaser of the product and from the original date of sale the following: Lifetime Warranty to the original end-user; the company will repair or replace, at its option, factory defective structural and mechanical parts with a comparable product without charge. This warranty is for a single shift, standard commercial usage, defined as a standard 8-hour workday, five days a week. Weight limitation varies by product. Upholstery fabric and foam are warranted against wear through and deterioration during normal usage for five (5) years. COM and COL are not warranted.

Wellness and Privacy Screens: Clear Plexiglas, Frosted Acrylic, and PET Wellness and Privacy Screens are warranted for 10 years from the date of delivery against defects in materials or workmanship, subject to the limitations exclusions and other provisions detailed below. This limited warranty only applies to the original purchaser. The limited warranty is terminated upon transfer, sale, or modification of the product. In no event, shall liability under this warranty exceed the original purchase price. This warranty does not apply to normal wear and tear or damage caused by accident, neglect, abuse, misuse, vandalism, disaster, improper storage, improper cleaning, chemical damage, improper installation, operation, environmental factors, or discoloration due to sunlight or indoor lighting. This warranty does not apply to changes in surface finish due to aging or prolonged exposure to fluids or sun. In the event of repair and/or replacement of any defective product, Special-T does not warrant matching color, texture, or dye lots except within commercially reasonable standards. This warranty is expressly made in lieu of any and all other warranties expressed or implied.

Labor Warranty is subject to written approval. It does not cover labor costs associated with concealed freight damage.



WARRANTY & RETURN

RETURN POLICY

The Return of any merchandise to the Special-T, LLC, warehouse must be authorized prior to shipment.

- All returns must be accompanied by a Return Merchandise Authorization Form (RMA). The RMA must be requested within thirty (30) days of the original invoice date. Please contact Customer Service at 888.705.0777, Monday to Friday, 8:00 AM to 5:00 PM EST. Upon approval of the return, send the prepaid shipment to 11820 Wills Road, Suite 140, Alpharetta, GA 30009-0256.
- Tops - 30% restocking fee will apply if received in new condition
- Bases - 25% restocking fee will apply if received in new condition
- Products must be in new condition and in their original carton
- The following items are non-returnable and non-refundable:
 - Custom table tops
 - Power and data units
 - Closeout tables and bases
 - Custom metal paint and Black Wrinkle finish
 - Metal bases with irreversible alterations

Customer Service:



888.705.0777



customerservice@specialt.net

CONTACT INFORMATION

Warranty:



888.705.0777



warranty@specialt.net



TABLES, BASES & ACCESSORIES



11820 Wills Rd, Suite 140,
Alpharetta, GA 30009
888.705.0777

www.SpecialT.net