

**TOOLS**



Impact Drill



#3 Phillips Bit



Safety Glasses

**PARTS & HARDWARE LIST**



**A**  
Tabletop  
(1)

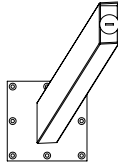

**B**  
AIMX LEFT  
(2)

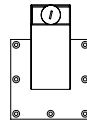

**C\***  
AIMX A  
Optional

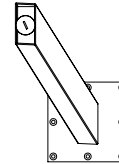

**D**  
AIMX RIGHT  
(2)



**E**  
Phillips Flat Head  
Wood screws

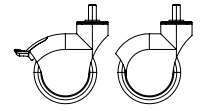

**F**  
Casters  
Optional

\*INCLUDED ON TABLES >84" LONG

**ASSEMBLY STEPS**



START BOLTS BY HAND TO PREVENT CROSS THREADING

1-2-3

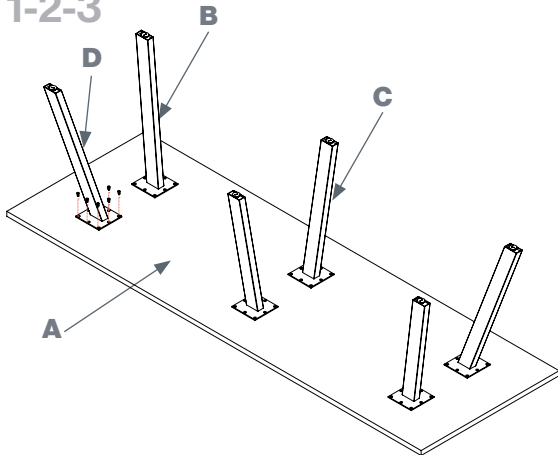

**1.** Lay the table top (A) upside down on a cardboard piece or carpeted surface.

**2.** Align the Left (B) and Right (D) AIM legs with the pre-drilled holes so the legs are angled towards the corners of the tabletop.

**3.** Align the AIM "A" (C) legs with the pre-drilled holes so the legs are angled towards the edges of the tabletop.

**4.** Fasten AIM legs to the tabletop using wood screws (E).

**5.** Have two people hold onto the edges of the tabletop and carefully turn the table over to the upright position.

4

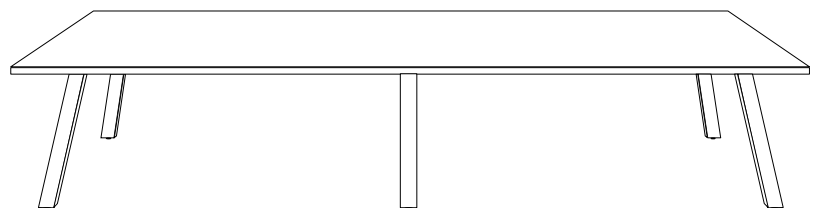
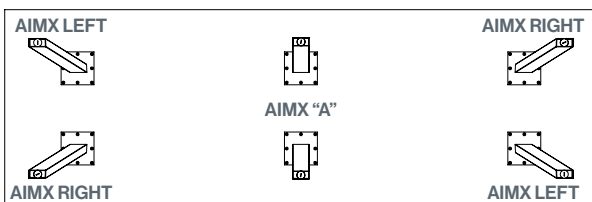

ASSEMBLED AIM-XL TABLE

FOR MISSING PARTS OR QUESTIONS, PLEASE CALL CUSTOMER SERVICE AT 888-705-0777.